

# IC CORPORATE INTERIORS

## Corporate Collection Brochure



*Office Furniture with a difference*

# INDEX

## ACCESSORIES 86

- POWER AND DATA
- MONITOR ARMS
- HAND SANITIZER



## CC PLUS STORAGE 84-85

## COFFEE TABLES 12-13



## CREDENZAS 28-33

- DESIGNER CREDENZAS
- STORAGE CREDENZAS
- LOW HEIGHT CREDENZAS
- FLOATING CREDENZAS

## DECORATIVE WALL PANELS 14-15



## DESKS 34-41

- SIT/STAND EXECUTIVE DESKS
- DESIGNER DESKS
- TWO TIER / TAILOR EXECUTIVE
- GEO EXECUTIVE RANGE
- OFFICE DESKS



## EDUCATION 81



## FLOAT WALL STORAGE 17

## GARDEN ROOM DIVIDERS 26-27



## LOCKERS 82-83



## METAL STORAGE 68-69



## RECEPTIONS 6-11

- DESIGNER RECEPTIONS
- RECEPTIONS
- MIES RANGE



## SEATING 70-80

- SOFT SEATING
- BREAKOUT CHAIRS
- NIKOLA CHAIRS
- TASK CHAIRS
- BOARDROOM CHAIRS
- TRAINING/ MEETING CHAIRS
- STOOLS



## SELECTRIC DESKS 56-57



## SLAT WALLS 16

## SONIK ACOUSTIC RANGE 52-54



## STORAGE 20-25

- DESIGNER STORAGE
- GRID LINE STORAGE
- GARDEN STORAGE
- WELDED STORAGE



## TABLES 42-51

- BOARDROOM TABLES
- MEETING TABLES
- BREAKOUT TABLES



## VERTICAL GARDENS 18-19

## WHITEBOARDS 55



## WORKSTATIONS 58-67

- VISTA
- FORUM
- PLAZA



---

# Summary

---



SELECTRIC DUO 402 - p. 57



VISTA WORKSTATION - p. 58



PLAZA WORKSTATION - p. 64



FORUM WORKSTATION - p. 60



LETO BOARDROOM - p. 45



HARBOUR BOARDROOM - p. 44



ORLANDO BOARDROOM - p. 43



ASA BOARDROOM - p. 43



FOCUS HIGH BENCH - p. 49



OFF THE WALL GARDEN TABLE - p. 49



TORO TABLE - p. 50



FALCON HIGH BENCH - p. 49



ASA SIDE TABLE - p. 13



HOST MOBILE FLIP TABLE - p. 48



ECLIPSE COFFEE TABLES- p. 13



BALU COFFEE TABLES- p. 13



ID DESK - p. 34



DELTA EXECUTIVE- p. 40



TAILOR EXECUTIVE - p. 37



VAULT EXECUTIVE DESK- p. 35

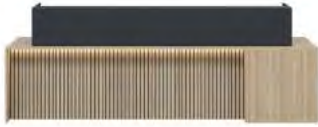

STERLING - p. 06



MADDOX- p. 07



AVA - p.08



LAYLA - p. 07



WILLOW PLANTER STORAGE - p. 22



UPTOWN BUFFET - p. 25



BOSLEY WELDED UNIT - p. 25



CAFE GARDEN STORAGE p. 23



MINI SPACE - p. 70



MIA ARM CHAIR - p. 71



PALM DIVIDER- p. 54



CURVE SLAT MINI SPACE -p. 16



YOYO - p. 77



NIKOLA CASTORS + ARMS - p. 78



BERKELEY TAN - p. 75



KNOX - p. 74



BREEZEWAY GARDEN - p. 18



MULTIPURPOSE WHITEBOARD p. 55



OFFSET VERTICAL GARDEN- p. 19



CURVED SLAT WALL- p. 16



LENA CREDENZA - p. 28



MILA II- p. 28



ONYX CREDENZA - p. 29



THE SPECTRE BAR- p. 30



RECEPTIONS

What does a beautiful designed front reception counter really represent? The answer is, it's everything about you and your brand. It's your first warm hello, your first point of contact and most importantly the first impression of you and what you do. Never hold back on the WOW factor! For more images please refer to our website.

**STERLING RECEPTION DESK**

**FEATURES**

Hob in Laminex Absolute Matte Black or White / Front Panels Feature Ink Lines



Left Hand Shown

CODE	DIMENSION
STRLNGRCP2109	2100W x 900D x 1100H
STRLNGRCP2409	2400W x 900D x 1100H
STRLNGRCP2709	2700W x 900D x 1100H
STRLNGRCP3009	3000W x 900D x 1100H

**LUSTO RECEPTION DESK**

**FEATURES**

Shown in a Laminate Marble look extrnal only / Plinth / Groove Line Pattern



**ORION RECEPTION DESK**

**FEATURES**

Hob in Laminex Absolute Matte Black or White / Front Panels Feature Ink Lines



CODE	DIMENSION
ORNRCP1809	1800W x 900D x 1100H
ORNRCP2109	2100W x 900D x 1100H
ORNRCP2409	2400W x 900D x 1100H
ORNRCP2709	2700W x 900D x 1100H
ORNRCP3009	3000W x 900D x 1100H

**ELIXIR RECEPTION DESK**

**FEATURES**

Elixir is the ferrari of all our receptions, the design in itself is a chameleon depending on what product is used. Finishes range anywhere from 2 pac to laminate.



### ROLLO RECEPTION DESK

**FEATURES**

A beautifully crafted design that uses board in a way that makes the eye travel  
Available in Standard 46 Colours



CODE	DIMENSION
RLLRCP1809	1800W x 900D x 1100H
RLLRCP2109	2100W x 900D x 1100H
RLLRCP2409	2400W x 900D x 1100H

### LAYLA RECEPTION DESK

**FEATURES**

A floating top and shadowline with winged ends and highlighted skirting  
Available in standard colours for body and special gold edging.



CODE	DIMENSION
LYLRCP1809	1800W x 900D x 1100H
LYLRCP2109	2100W x 900D x 1100H
LYLRCP2409	2400W x 900D x 1100H

### MADDOX RECEPTION DESK

**FEATURES**

Laminated Stone Look Panel with LED option / Horizontal Ink Line Grooves  
Available in standard colours for body and laminate front panel.



CODE	DIMENSION
MDDXRCP1809	1800W x 900D x 1100H
MDDXRCP2109	2100W x 900D x 1100H
MDDXRCP2409	2400W x 900D x 1100H

### IRIS RECEPTION DESK

**FEATURES**

Recessed front / Boxed in frame high lighted with warm LED lights and birdsmouth overhang. Available in standard colours

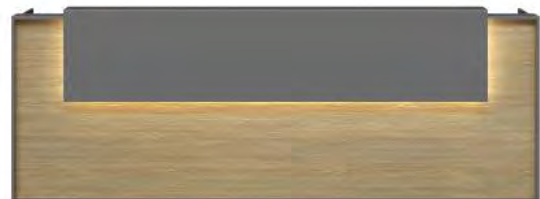

CODE	DIMENSION
IRSRCP1809	1800W x 900D x 1100H
IRSRCP2109	2100W x 900D x 1100H
IRSRCP2409	2400W x 900D x 1100H

### SKYE RECEPTION DESK

**FEATURES**

Shown in Laminex Manhattan Concrete 18mm / 19mm Tube Frame  
Boxed in base and welded frame feature / Plants Optional  
Available in standard colours



CODE	DIMENSION
SKYERCP1809	1800W x 900D x 1100H
SKYERCP2109	2100W x 900D x 1100H
SKYERCP2409	2400W x 900D x 1100H
OPTION	PLANTS

### MANHATTAN RECEPTION DESK

**FEATURES**

Shown in Laminex Manhattan Concrete 18mm  
Available in standard colours



CODE	DIMENSION
MNHTNRCP1809	1800W x 900D x 1100H
MNHTNRCP2109	2100W x 900D x 1100H
MNHTNRCP2409	2400W x 900D x 1100H



Reception counters with a point of difference. We love the luxury and warmth that our designs can bring to any entrance. For custom reception desk images, please refer to our website.

### ROXI FRONT PANEL RECEPTION DESK

**FEATURES**

Ink Line Grooves for the Timber Batten Look / Slim curved up lifted privacy panel / White Panel On Front allows option for personalised Logo to be featured

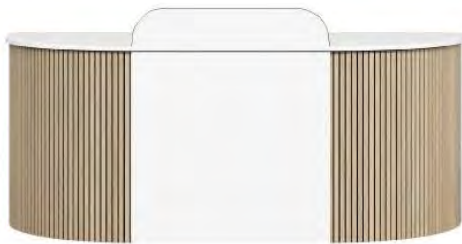

CODE	DIMENSION
RXCIFRTPNLRCP018	1800W x 900D x 1100H
RXCIFRTPNLRCP021	2100W x 900D x 1100H
RXCIFRTPNLRCP024	2400W x 900D x 1100H

### ROXI ARENA RECEPTION DESK - PLINTH

**FEATURES**

Ink Line Grooves for the Timber Batten Look / Includes Plinth and LED Lights



CODE	DIMENSION
ROXIARENA2109	2100L x 900D x 1100H
ROXIARENA2409	2400L x 900D x 1100H
ROXIARENA3009	3000L x 900D x 1100H

### AVA RECEPTION DESK

**FEATURES**

Ink Line Grooves for the Timber Batten Look / LED Lights Optional for Full Effect 1800mm and longer Ava Receptions, the grain will run horizontal



CODE	DIMENSION
AVARCP018	1800W x 900D x 1100H
AVARCP021	2100W x 900D x 1100H
AVARCP024	2400W x 900D x 1100H
AVARCP027	2700W x 900D x 1100H
AVARCP030	3000W x 900D x 1100H

### ROXI MINI RECEPTION DESK

**FEATURES**

Ink Line Grooves for the Timber Batten Look / Slim curved up lifted privacy panel / White Panel On Front allows option for personalised Logo to be featured



Right Hand Shown

CODE	DIMENSION
ROXIMINIRCP018	1800W x 900D x 750H
ROXIMINIRCP021	2100W x 900D x 750H
ROXIMINIRCP021	2400W x 900D x 750H



### JAZZ RECEPTION DESK

**FEATURES**

With elegant long linear lines, combining lap and birds-mouth joins, the Jazz is an absolute stunner!



Left Hand Shown

CODE	DIMENSION
JZREC240811	2400W x 900D x 1100H
JZREC270811	2700W x 900D x 1100H
JZREC300811	3000W x 900D x 1100H

### MIES 101 SELECTRIC OPERATOR

**FEATURES**

The Mies Selectric combines superior flexibility and quality in electronically operated true sit/stand desk. It's the ideal solution for changing your working position throughout the day, thus transforming the way you work.

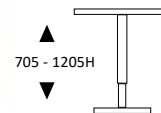

CODE	DIMENSION
MISEL210812	2100W x 850D x 705 ~ 1205H

(Privacy Panel on the Left Hand from Operators Side shown)

### SPLIT RECEPTION DESK

**FEATURES**

Its linear two tier design creates an inviting interactive space between receptionist and client, making it easily accessible for clients who are in wheelchairs or need to sit for short periods. Ideal for medical practices, hospitals and aged care.

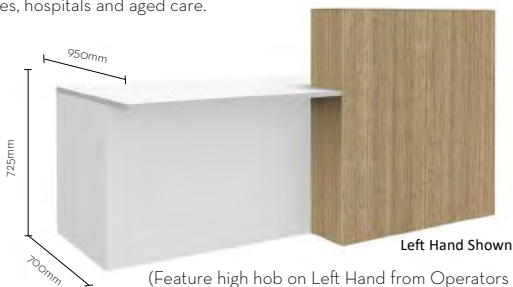

Left Hand Shown

(Feature high hob on Left Hand from Operators Side shown)

CODE	DIMENSION
SPLITRECHO1809	1800W x 950D x 1100H
SPLITRECHO2109	2100W x 950D x 1100H
SPLITRECHO2409	2400W x 950D x 1100H

### APEX-LITE RECEPTION DESK

**FEATURES**

Simplified version of the Apex reception counter.



CODE	DIMENSION
ALRD18	1800W x 925D x 1100H
ALRD21	2100W x 925D x 1100H
ALRD24	2400W x 925D x 1100H
ALRD27	2700W x 925D x 1100H
ALRD30	3000W x 925D x 1100H

### AXIS RECEPTION DESK

**FEATURES**

Make an impression and standout with a show stopping reception, with careful consideration to detail in its joins and overall aesthetic.



CODE	DIMENSION
AXISRD21	(2100W x 900D) x (1800W x 600D) x 1072H
AXISRD24	(2400W x 900D) x (1800W x 600D) x 1072H

### RECEPTION RETURN OPTIONS

A quick guide to a basic reception return options that are easily adaptable to most of our other designs



RETURN - A

RETURN - B

RETURN - C

RETURN	CODE	DIMENSION
A	RETURE09A	900W x 600D x 725H
	RETURE012A	1200W x 600D x 725H
B	RETURE09B	900W x 600D x 1100H
	RETURE012B	1200W x 600D x 1100H
C	RETURE09C	900W x 600D x 1100H
	RETURE012C	1200W x 600D x 1100H



# MIES MODULAR RECEPTIONS

The Mies Range of receptions are designed to be modern and modular for its easy construction method. With easy add ons to create an individual look. With 46 colours on offer and endless design looks. Mies can transform a space that is warm welcoming and affordable.

## MIES BASE MODEL

### FEATURES

Flush Counter top



CODE	DIMENSION
MIESRECLP1808	1800W x 850D x 1100H
MIESRECLP2108	2100W x 850D x 1100H
MIESRECLP2408	2400W x 850D x 1100H

## MIES SHADOW

### FEATURES

Full Length Short Overhang Panel with Counter top / LED Option Available



CODE	DIMENSION
MIESRECLPSH1808	1800W x 850D x 1100H
MIESRECLPSH2108	2100W x 850D x 1100H
MIESRECLPSH2408	2400W x 850D x 1100H

## MIES OPERATOR

### FEATURES

Rounded Square /Oval Panel and 3 Quarter Frame in Contrast Colour



Left Hand Shown

CODE	DIMENSION
MIESRECLPOP1808	1800W x 850D x 1100H
MIESRECLPOP2108	2100W x 850D x 1100H
MIESRECLPOP2408	2400W x 850D x 1100H

## MIES AVALANCHE

### FEATURES

Full width overhang panel / LED Option Available



CODE	DIMENSION
MIESRECLPAV1808	1800W x 850D x 1100H
MIESRECLPAV2108	2100W x 850D x 1100H
MIESRECLPAV2408	2400W x 850D x 1100H

### MIES RIBBON

#### FEATURES

Contrast Panel wrapped around all sides



CODE	DIMENSION
MIESRECLPRB1808	1800W x 850D x 1100H
MIESRECLPRB2108	2100W x 850D x 1100H
MIESRECLPRB2408	2400W x 850D x 1100H

### MIES COUNTER TOP

#### FEATURES

Contrast Counter Top



CODE	DIMENSION
MIESRECLPCT1808	1800W x 850D x 1100H
MIESRECLPCT2108	2100W x 850D x 1100H
MIESRECLPCT2408	2400W x 850D x 1100H

### MIES WATERFALL

#### FEATURES

Waterfall counter top in contrasting Colour / LED Option Available



CODE	DIMENSION
MIESRECLPWF1808	1800W x 850D x 1100H
MIESRECLPWF2108	2100W x 850D x 1100H
MIESRECLPWF2408	2400W x 850D x 1100H

### MIES COVET

#### FEATURES

An angled cover top over desk height counter



Right Hand Shown

CODE	DIMENSION
MIESRECLPCO1808	1800W x 850D x 1100H
MIESRECLPCO2108	2100W x 850D x 1100H
MIESRECLPCO2408	2400W x 850D x 1100H

### MIES FULL FRAME

#### FEATURES

Counter top that finishes to the floor on both sides with slight overhang for shadow effect



CODE	DIMENSION
MIESRECLPFF1808	1800W x 850D x 1100H
MIESRECLPFF2108	2100W x 850D x 1100H
MIESRECLPFF2408	2400W x 850D x 1100H

### MIES BEVEL END

#### FEATURES

Contrast Angled on One Side / LED Option Available



Right Hand Shown

CODE	DIMENSION
MIESRECLPBE1808	1800W x 850D x 1100H
MIESRECLPBE2108	2100W x 850D x 1100H
MIESRECLPBE2408	2400W x 850D x 1100H

### MIES BOXER

#### FEATURES

One side boxed in a contrast colour



Right Hand Shown

CODE	DIMENSION
MIESRECLPBX1808	1800W x 850D x 1100H
MIESRECLPBX2108	2100W x 850D x 1100H
MIESRECLPBX2408	2400W x 850D x 1100H

### MIES SUMMIT - INK LINES

#### FEATURES

Side panels are white / Front Panel Ink Lines

LED Option Available



Right Hand Shown

CODE	DIMENSION
MIESRECLPSU1808	1800W x 850D x 1100H
MIESRECLPSU2108	2100W x 850D x 1100H
MIESRECLPSU2408	2400W x 850D x 1100H



# COFFEE TABLES

It's the centre ring that ties a space together and brings the focal point to a dedicated area. You want it to be comfortable, welcoming and inviting, all at the same time. It may be a small piece of furniture added to a casual breakout area, or a grand reception space. Coffee tables allow you the space to add your personality through decor and accessories, creating a mood or a place you would be happy to put down your coffee cup.

## JAX COFFEE TABLE

25mm Thickness / Size Shown 700



CODE	DIMENSION
JAXCT070	Ø700 x 350H
JAXCT080	Ø900 x 350H

## KYLO COFFEE TABLE

18mm Thickness  
Special Colours Refer to Page 89



\*Laminex Hushed Pine

CODE	DIMENSION
KYLOCF070	700Ø x 400H
KYLOCF010	900Ø x 400H

## ARC COFFEE TABLE

18mm Thickness / Size Shown 1200 x 600D



CODE	DIMENSION
ARCCT090	900 x 500D x 350H
ARCCT012	1200 x 600D x 350H

## ZEEV COFFEE TABLE

18mm Thickness



CODE	DIMENSION
ZEEVCT012	1200 x 600D x 400H

## FELIX TABLE

18mm Thickness Top / Size Shown 900  
Special Colours Refer to Page 89



\*Laminex Manhattan

CODE	DIMENSION
FELIXCT070	700W x 700D x 350H
FELIXCT090	900W x 900D x 350H

## MARLI COFFEE TABLE

18mm Thickness / Size Shown 700



CODE	DIMENSION
MARLICCT070	Ø700 x 400H
MARLICCT090	Ø900 x 400H

**ASA SIDE/ COFFEE TABLE**

18mm Thickness  
Special Colours Refer to Page 89



\*Black Nuance Finish

CODE	DIMENSION
ASACT4045	400Ø x 450H
ASACT4055	400Ø x 550H

**MONTY COFFEE TABLE SET**

Special Colours Refer to Page 89



\*Laminex Manhattan Concrete

CODE	DIMENSION
MNTYCFSM	500Ø x 400H
MNTYCFG	900L x 500D x 350H

**HART SIDE TABLE**

18mm MDF Drop Shape Top with Shark Nose Edge  
Steel Ø25 Column & Teardrop Shape Base  
AVAILABLE IN BLACK ONLY



CODE	DIMENSION
IFHACOTABL	305W x 410D x 450H
IFHAMTTABL	305W x 410D x 600H

**BOBBI SIDE TABLE**

18mm Thickness Special Colours Refer to Page 89



400mm

CODE	DIMENSION
BOBBISD	350Ø x 600H

**BALU COFFEE TABLE**

18mm Thickness Special Colours Refer to Page 89



\*Laminex Manhattan Concrete

CODE	DIMENSION
BALUCFT050	700L x 350D x 320H
BALUCFT070	700L x 350D x 420H

**ECLIPSE COFFEE TABLE**

Top: 18mm Melamine  
Base: Black Steel Round Tube  
Top Colour Any Standard 46



CODE	DIMENSION
IMECCFB05BL	Ø500 x 500H
IMECCFB07BL	Ø700 x 460H
IMECCFB09BL	Ø900 x 420H

**AIR - ROUND COFFEE TABLE**

Top: 18mm Melamine  
Base: 10x20mm Polished Stainless Steel (PO) / Black (BL)



CODE	DIMENSION
IMCRRDOP006	Ø600 x 450H

**AIR - COFFEE TABLE**

Top: 18mm Melamine  
Base: 10x20mm Polished Stainless Steel (PO) / Black (BL)



CODE	DIMENSION
IMCRSQ12PO	Ø1300 x 450H

**AIR - OVAL COFFEE TABLE**

1300mm Top Shown / Top: 18mm Melamine  
Polished Stainless Steel (PO) / Black (BL)



CODE	DIMENSION
IMCRSQ13PO	1300W x 450H

**ARRO COFFEE TABLE**

18mm Thickness Top / Triangular Slab Legs  
Special Colours Refer to Page 89



\*Laminex Black Nuance

CODE	DIMENSION
ARROCF090	900W x 500D x 400H
ARROCF012	1200W x 600D x 400H

**GABE COFFEE TABLE**

18mm Thickness Top / Fully Welded Frame  
Special Colours Refer to Page 89



\*Laminex Black Nuance

CODE	DIMENSION
GABECFT090	900L x 600D x 400H
GABECFT012	1200L x 700D x 400H

**VERSE COFFEE TABLE**

18mm Thickness Top



CODE	DIMENSION
IMVSCBAPO	Ø600 x 440H (Round)
IMVSRCTBAPO	600W x 600D x 440H (Square)



Stand out for all the right reasons. Create the 'WOW' factor on your next project with our Decorative Wall Panels. With panelling on trend we have developed some stunning designs; but allow the option to personalise your own look. Our Decorative Wall Panels can be fixed onto most interior walls. They are an easy inclusion which add texture and warmth to any space. Get excited styling your next fitout project; with 46 colours to choose from. All Panels come in an 18mm thickness.

**INK LINE DECORATIVE PANEL**

CODE	HEIGHT RANGE	PANEL WIDTHS
FPINLDP	1800 ~ 2700mm	Custom

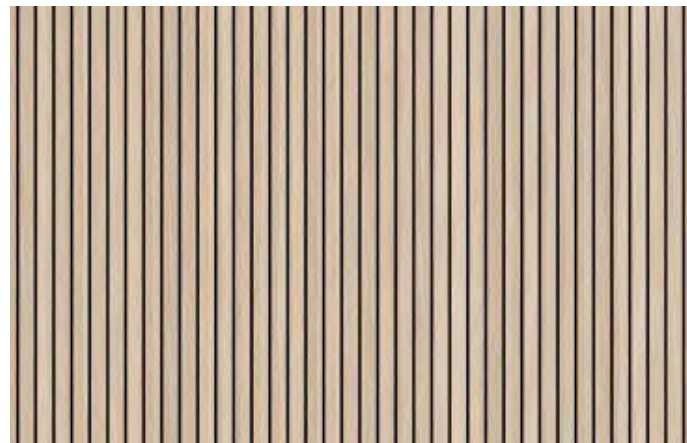

**BELT LINE DECORATIVE PANEL**

CODE	HEIGHT RANGE	PANEL WIDTHS
FPBTLDP	1800 ~ 2700mm	Custom



**TILE LINE DECORATIVE PANEL**

CODE	HEIGHT RANGE	PANEL WIDTHS
FPTLLDP	1800 ~ 2700mm	Custom

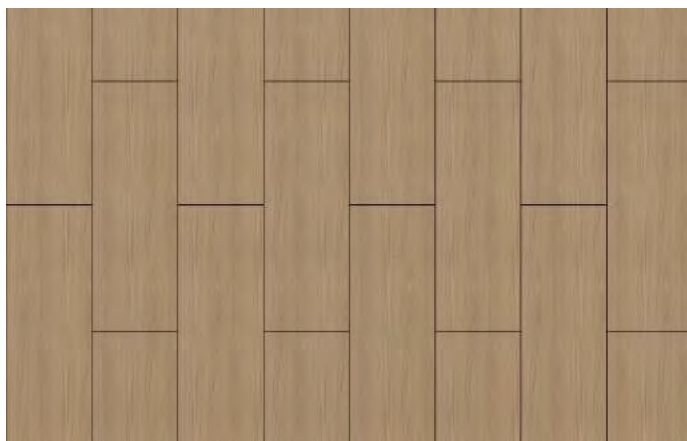

**OFFSET TILE LINE DECORATIVE PANEL**

CODE	HEIGHT RANGE	PANEL WIDTHS
FPOFTDP	1800 ~ 2700mm	Custom

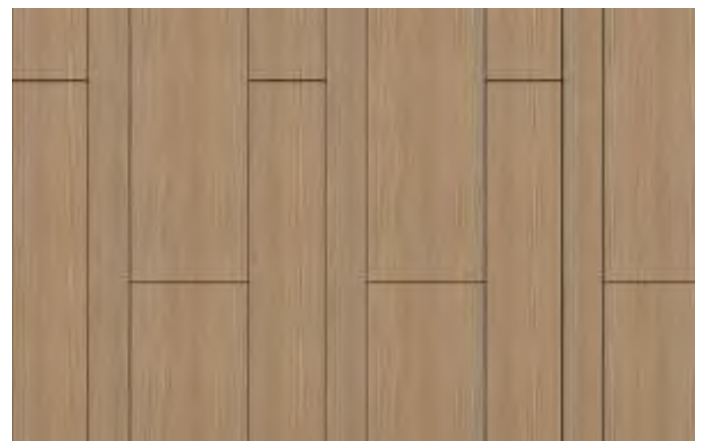

**AXIS DECORATIVE PANEL**

CODE	HEIGHT RANGE	PANEL WIDTHS
FPAXIDP	1800 ~ 2700mm	Custom

**LEXI DECORATIVE PANEL**

CODE	HEIGHT RANGE	PANEL WIDTHS
FPLEXDP	1800 ~ 2700mm	Custom

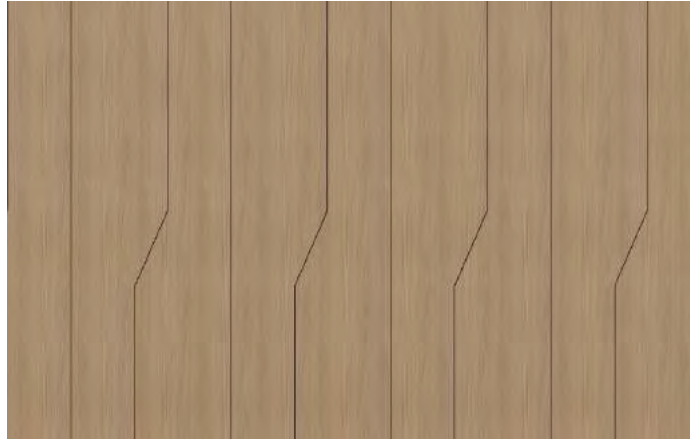
**ALATE DECORATIVE PANEL**

CODE	HEIGHT RANGE	PANEL WIDTHS
FPALDTP	1800 ~ 2700mm	Custom

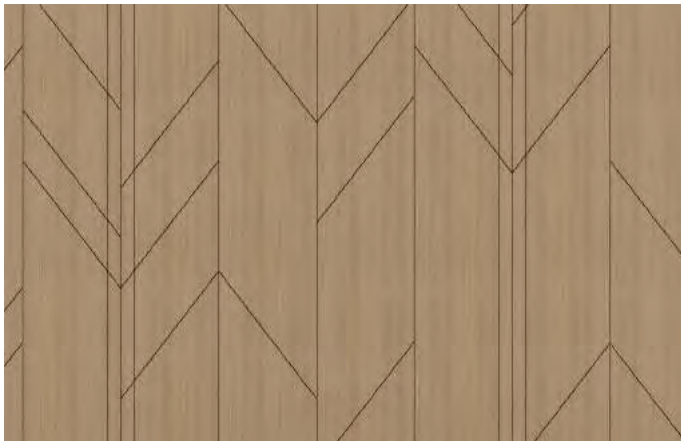
**YIMA DECORATIVE PANEL**

CODE	HEIGHT RANGE	PANEL WIDTHS
FPYMADP	1800 ~ 2700mm	Custom

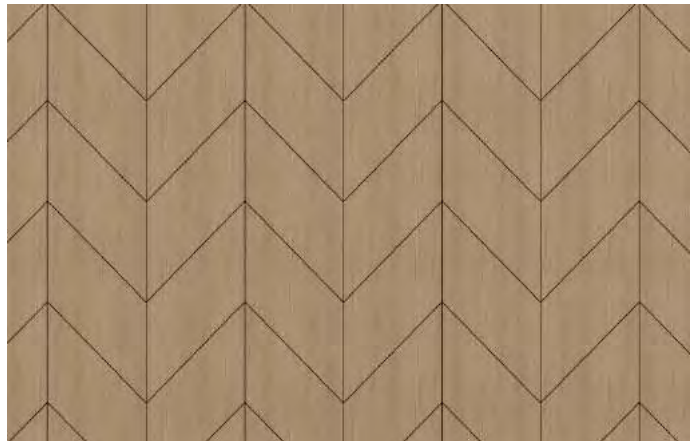
**HERRINGBONE DECORATIVE PANEL**

CODE	HEIGHT RANGE	PANEL WIDTHS
FPHRBDP	1800 ~ 2700mm	Custom

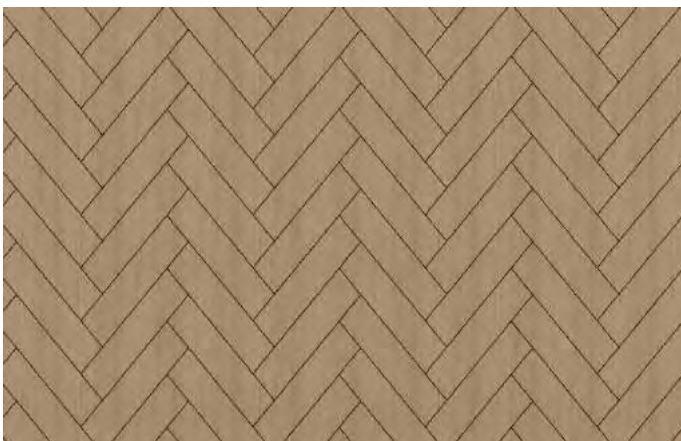
**HEX DECORATIVE PANEL**

CODE	HEIGHT RANGE	PANEL WIDTHS
FPHEXDP	1800 ~ 2700mm	Custom

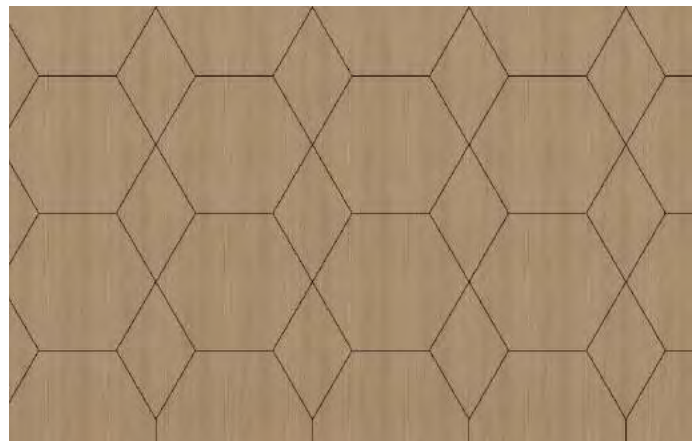



# SLAT WALLS

Our Melamine Slat Walls have a place in every workspace, they offer the flexibility of privacy as well as serving as a decorative feature. Our Slat Walls inspire interaction. While creating breakout areas without being concealed behind solid walls, your workspace will continue to inspire collaboration and productivity. With the flexibility of the widths and heights of our Slat Walls and 46 colours options, they can belong in any area of the workplace.

## STRAIGHT SLAT WALL

### FEATURES

140mm Width Slats / Choice of 46 Standard Colours / Up to 2700H  
Requires to Be Fixed to Wall and/ Or Floor / 12 Slats per metre including ends

FRONT VIEW

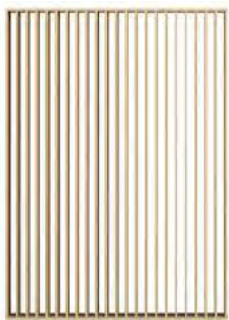

ANGLED VIEW



\*Planter Boxes pg. 19



## ANGLE SLAT WALL

### FEATURES

140mm Width Slats / Choice of 46 Standard Colours / Up to 2700H  
Requires to Be Fixed to Wall and/ Or Floor / 7 angled slats per metre

FRONT VIEW



ANGLED VIEW



## TILT WALL

### FEATURES

Purpose Built / Pictured in Heroshot Above  
Made to Measure



## FULL FRAMED SLAT WALL

### FEATURES

Purpose Built 140mm Deep Slats  
Made to Measure

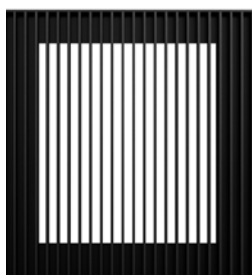

## CURVED SLAT WALL

### FEATURES

140mm Width Slats / Choice of 46 Standard Colours / Up to 2700H  
/ Preferred Radius Required  
Requires to Be Fixed to Wall and/ Or Floor







# FLOAT WALL STORAGE

Floating Wall Storage is so versatile and can be used in many applications. From showcasing products, brochures etc in a reception area, or adding executive storage with a decorative flair, these units serve as multipurpose designs.

## BOX WALL CLUSTER

**FEATURES**  
Fits Lever Arch Folders



CODE	DIMENSION
BXWLST025	250 W x 330D x 400H
BXWLST040	400 W x 330D x 400H
BXWLST060	600 W x 330D x 400H
BXWLST075	750 W x 330D x 400H

## BOXED WALL SHELF

**FEATURES**  
Fits Lever Arch Folders  
Sizes 1200mm and greater include a divider



CODE	DIMENSION	DIVIDER
BXWLST090	900 W x 330D x 400H	0
BXWLST012	1200 W x 330D x 400H	1
BXWLST015	1500 W x 330D x 400H	1
BXWLST018	1800 W x 330D x 400H	1

## FLEX WALL STORAGE

**FEATURES**  
Display Wall Unit

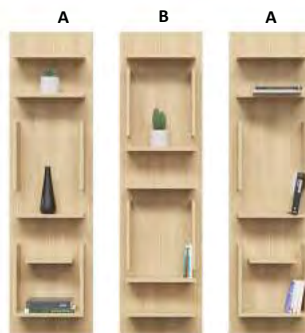

CODE	UNIT	DIMENSION
FLXWLLST045A	A	450 W x 150D x 1600H
FLXWLLST045B	B	450 W x 150D x 1600H

## CURVED END OPEN WALL UNIT

**FEATURES**  
Fits Lever Arch Folders



CODE	DIMENSION
OPWLST090	900 W x 330D x 400H
OPWLST012	1200 W x 330D x 400H
OPWLST015	1500 W x 330D x 400H
OPWLST018	1800 W x 330D x 400H

## EKKO WALL STORAGE

**FEATURES**  
Pull To Open Doors / Encased in Frame



CODE	DIMENSION
EKWLLST045	450W x 300D x 1700H (A)
EKWLLST080	800W x 300D x 1700H (B)

## TV WALL UNIT

**FEATURES**  
Suits 42 Inch TV / TV and Bracket NOT Supplied



CODE	DIMENSION
TVWLLUT	1800W x 150D x 1200H



# VERTICAL GARDENS

Vertical Gardens are now the new norm in every office space. Adding greenery is the simplest way to bring life back into the workspace, creating an environment that people want to work in. Vertical Gardens can be used to create breakout areas to encourage collaboration amongst staff, and also offer a quiet space bringing nature to you.

## VERTICAL GARDEN WALL

### FEATURES

Our Vertical Garden Wall has option for Upright Plants and now more cost effective hanging plants

VERSION 1



VERSION 2



\*Plants Indicative Only  
\*Plants Subject To Availability

## BREEZEWAY GARDEN

### FEATURES

Frame Finish: Powder-coated Black / White  
Shelves Choice of 46 Standard Colours



\*Plants Indicative Only

CODE	DIMENSION
WLKPL0905	1200W x 350D x 1800H

\*Plants Subject To Availability

### UPSTAND VERTICAL GARDEN

**FEATURES**

Choice of 46 Standard Colours / Pebbles in Base



### OFFSET VERTICAL GARDEN

**FEATURES**

Frame Finish: Powder-coated Black / White Shelves Choice of 46 Standard Colours Available with and without storage



1200W



3600W

CODE	DIMENSION
UPSTVG012	1200W x 300D x 1800H

\*Plants Indicative Only  
\*Plants Subject To Availability

CODE	DIMENSION
OFFSETVERG1222	1200W x 350D x 2200H
OFFSETVERG3622	3600W x 350D x 2200H

### CAFE VERTICAL GARDEN

**FEATURES**

Frame Finish: Powder-coated Black / White / Choice of 46 Standard Colours / No Storage / Double Sided Design (Plants feature on both sides of the unit) Birds-mouth Joins/ Available with and without storage



### CORRIDOR VERTICAL GARDEN

**FEATURES**

Choice of 46 Standard Colours Available with and without storage



1200W



2640W

800mm H

CODE	DIMENSION
CAFEVERTP1218	1200W x 350D x 1800H

\*Plants Subject To Availability

CODE	DIMENSION	NO OF PLANTS
CORRVG	1200W x 350D x 1830H	6
OPTION	2640W x 350D x 1830H	14

\*Plants Subject To Availability

### CEILING HANGING PLANTER

**FEATURES**

Frame Finish: Powder-coated Black / White Perforated Base / Not Suitable for Real Plants Installation by Qualified Builder required



\*Plants Subject To Availability

### FLOATING GARDEN BEDS

**FEATURES**

Decorative Planter suits to be attached to Decorative & Slat Walls also storage units and high benches / Birdsmouth Joins Wall LED Planter Suits Decorative Walls and Plaster Walls

DECORATIVE PLANTER



WALL LED PLANTER



\*Plants Indicative Only

\*More sizes available in sizes 300W 500W 700W

CODE	DIMENSION
DECLPLNT9020	900W x 200D x 200H
WLLPLNT9020	900W x 200D x 270H
OPTION	Plants To Suit

\*Plants Subject To Availability

### WALKWAY PLANTER

**FEATURES**

Frame Finish: Powder-coated Black / White Black or White Perforated Planter



\*Plants Subject To Availability

CODE	DIMENSION
WLKPL0905	900W x 450D x 970H
OPTION	Plants and Bark



# DESIGNER STORAGE

The thinking behind these multipurpose designer storage units, is that they can be used to line a wall, create a breakout area or a corridor, while still offering functionality and design in any creative workspace.

## SHOWCASE DISPLAY UNIT



**FEATURES**  
Two Toned Display Open Display Unit / Adjustable Feet

CODE	PART	DIMENSION
SHCSDSUT090	A + B	1800W x 400D x 2280H
SHCSDSUT024	A+B+A	2400W x 400D x 2280H

## VISION MULTIPURPOSE WALL UNIT



**SONIK ACOUSTIC PANEL COLOURS**

- LIGHT GREY
- MID GREY
- DARK CHARCOAL

**FEATURES**  
Acoustic Sonik Pinboard / Slanted Shelf For Display Purposes / 2 Door Cupboard / Adjustable Feet

CODE	DIMENSION	DOORS
VSMPWLUT9018	900 W x 450D x 1800H	2
VSMPWLUT1218	1200 W x 450D x 1800H	2
VSMPWLUT9021	900 W x 450D x 2100H	2
VSMPWLUT1221	1200 W x 450D x 2100H	2

## DIAZ OPEN STORAGE UNIT



**FEATURES**  
Open Multi Shelf Unit With Half Open Back / Internal Shelves 350H

CODE	DIMENSION
DZOPSTUT105	1050W x 400D x 2280H

## SHADOWLINE CUPBOARD RANGE



**FEATURES**  
Shadowline Feature / Finger Grip / Adjustable Feet / Platter Base / More Sizes Available

CODE	DIMENSION	DOORS	SHELVES
FDCPSH090	900 W x 450D x 1800H	4	4
TDCPSH090	900 W x 450D x 1800H	2	4
HFBSCP090	900 W x 450D x 1800H	2	3
OPBSSH090	900 W x 450D x 1800H	0	4

### GRID LINE - FULL BACK LOW UNIT



\*Shown Absolute Matte Black

#### FEATURES

Platter Base to Appear Floating off the floor/ Contrast Edging / Adjustable Feet / 25mm Construction / Choice of colours shown on pages 87, 88 & 89

CODE	DIMENSION
SDTGRID9004	900 W x 450D x 725H
SDTGRID1204	1200 W x 450D x 725H
SDTGRID1504	1500 W x 450D x 725H
SDTGRID1804	1800 W x 450D x 725H

### GRID LINE - HALF BACK LOW UNIT



\*Shown Absolute Matte Black

#### FEATURES

Platter Base to Appear Floating off the floor/ Contrast Edging / 25mm Construction / Adjustable Feet Choice of colours shown on pages 87, 88 & 89

CODE	DIMENSION
SDTGRID9004	900 W x 450D x 725H
SDTGRID1204	1200 W x 450D x 725H
SDTGRID1504	1500 W x 450D x 725H
SDTGRID1804	1800 W x 450D x 725H

### GRID LINE LOW STORAGE - LOW



\*Shown Absolute Matte Black

#### SLIDING DOOR CREDENZA

Platter Base to Appear Floating off the floor/ Contrast Edging / Small Recessed Round Handle / Adjustable Feet. Choice of colours shown on pages 87, 88 & 89

CODE	DIMENSION	SHELVES
SDLGRID9004	900 W x 450D x 725H	1
SDLGRID1204	1200 W x 450D x 725H	1
SDLGRID1504	1500 W x 450D x 725H	1
SDLGRID1804	1800 W x 450D x 725H	1
SDLGRID2104	2100 W x 450D x 725H	1
SDLGRID2404	2400 W x 450D x 725H	1

### GRID LINE STORAGE - MID HEIGHT



\*Shown Absolute Matte Black

#### SLIDING DOOR CREDENZA

Platter Base to Appear Floating off the floor/ Contrast Edging / Small Recessed Round Handle / Adjustable Feet. Choice of colours shown on pages 87, 88 & 89

CODE	DIMENSION	SHELVES
SDLGRID9004	900 W x 450D x 900H	1
SDLGRID1204	1200 W x 450D x 900H	1
SDLGRID1504	1500 W x 450D x 900H	1
SDLGRID1804	1800 W x 450D x 900H	1
SDLGRID2104	2100 W x 450D x 900H	1
SDLGRID2404	2400 W x 450D x 900H	1

### GRID LINE STORAGE - TALL

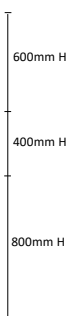

\*Shown with Locks

\*Shown Absolute Matte Black

#### SLIDING DOOR MULTI SHELF TALL UNIT

Platter Base to Appear Floating off the floor/ Contrast Edging / Top and Bottom Sliding Doors / Small Recessed Round Handle / Choice of colours shown on pages 87, 88 & 89

CODE	DIMENSION
SDTGRID7004	900 W x 450D x 1800H
SDTGRID9004	1200 W x 450D x 1800H

### GRID LINE PLANNER BENCH

Planter Boxes p. 19



#### FEATURES

Platter Base to Appear Floating off the floor / Open Storage / Double Sided Contrast Edge / Optional Planter Box / Platter Base / Planter Box to Suit p. 19

CODE	DIMENSION
SDTGRIDPLANNERBNCH2109	2100W x 900D x 1000H



## GARDEN STORAGE

We have expanded our range of Storage that accommodates Faux Plants and Greenery. These Storage solutions are a great bookend to a workstation or a practical room divider that allows for practical and hidden storage solutions as well as accommodating greenery which uplifts every workspace. All Made to Order and available in 46 Standard colours or other colour specifications.

### GRID LINE PLANTER STORAGE



#### FEATURES

Sliding Doors / Shadowline Uplift / Slimline Design/ 1100H + 250H Planter Overall  
1350H / 9mm Shadowline / Platter Base / Planter Box with Adjustable Internal Platter  
/ Small Recessed Round Handle / Adjustable Feet

CODE	DIMENSION
SDPS900	900W x 400D x 1350H
SDPS1200	1200W x 400D x 1350H
SDPS1500	1500W x 400D x 1350H
SDPS1800	1800W x 400D x 1350H

### WILLOW PLANTER WITH STORAGE



#### FEATURES

Adjustable internal platter for planter box so internal height can be adjusted /  
Push To Open / Plinth Base / Adjustable Feet

CODE	DIMENSION
WLPS900	900W x 400D x 1350H
WLPS1200	1200W x 400D x 1350H
WLPS1500	1500W x 400D x 1350H
WLPS1800	1800W x 400D x 1350H

### SLIDING DOOR PLANTER STORAGE



**FEATURES**

Shadowline Uplift / 1 Shelf / 19mm Square Tube Legs / Planter Box with Adjustable Internal Platter / Small Recessed Handle / Adjustable Feet

CODE	DIMENSION
SDPS900	900W x 400D x 1350H
SDPS1200	1200W x 400D x 1350H
SDPS1500	1500W x 400D x 1350H
SDPS1800	1800W x 400D x 1350H

### FULL FRAME PLANTER STORAGE



**FEATURES**

Shadowline Uplift / Slimline Design 19mm Tube Base / Planter Box with Adjustable Internal Platter/ Adjustable Feet

CODE	DIMENSION
FFPS900	900W x 400D x 1350H
FFPS1200	1200W x 400D x 1350H
FFPS1500	1500W x 400D x 1350H
FFPS1800	1800W x 400D x 1350H

### CAFE PLANTER WITH STORAGE



**FEATURES**

Plants to Be Seen on Both Sides / Push To Open Doors / Doors on One Side 19mm Tube Frame / Adjustable Feet / Plants are Hanging Not Dracaena

CODE	DIMENSION
CFPL900	900W x 400D x 1800H
CFPL1200	1200W x 400D x 1800H
CFPL1500	1500W x 400D x 1800H
CFPL1800	1800W x 400D x 1800H

Hanging Plants provided may vary According to Stock Availability

### PLANTER BOX CUPBOARD OPEN STORAGE



**FEATURES**

Open Storage Cavity/ 1 Adjustable Shelf/ Adjustable Feet/ Planter Box with Adjustable Internal Platter / Adjustable Feet

CODE	DIMENSION
MEPL090509	900W x 400D x 1350H
MEPL090512	1200W x 400D x 1350H
MEPL090515	1500W x 400D x 1350H
MEPL090518	1800W x 400D x 1350H



Dracaena



Black Bark

### ARTIFICIAL PLANTS

CODE	DIMENSION	POT DIMENSION
DRACAENART	550 x 550 x 600H	13cm (D) x 11cm (H)

\*Plants Subject to Stock Availability



WELDED STORAGE

**XENA WELDED UNIT**



**FEATURES**

Black or White Powdercoat Finishes / Large Drawers / 2 Fixed Shelves

CODE	DIMENSION
XNWDUT075	750W x 485D x 2050H
XNWDUT090	900W x 485D x 2050H
XNWDUT018	1800W x 485D x 2050H
XNWDUT022	2250W x 485D x 2050H
XNWDUT027	2700W x 485D x 2050H

**HUD WELDED STORAGE UNIT**



**FEATURES**

Black or White Powdercoat Finishes/ 850H Cabinet / 150H Uplift Back Panel / Single Rail at rear / Tea/Coffee Station or Printing Area / Open Top

CODE	DIMENSION	DOORS
HDWLSTUT090	900W x 400D x 1800H	2
HDWLSTUT012	1200W x 400D x 1800H	2
HDWLSTUT013	1350W x 400D x 1800H	3
HDWLSTUT015	1500W x 400D x 1800H	4
HDWLSTUT018	1800W x 400D x 1800H	4

**HALO WELDED STORAGE UNIT**



**FEATURES**

Storage Cabinet / Welded Frame with Uplift Shelving / Top Included

CODE	DIMENSION	DOORS
HLWDSTUT090	900W x 400D x 2000H	2
HLWDSTUT012	1200W x 400D x 2000H	2
HLWDSTUT013	1350W x 400D x 2000H	3
HLWDSTUT015	1500W x 400D x 2000H	4
HLWDSTUT018	1800W x 400D x 2000H	4

**HELIX WELDED STORAGE UNIT**



**FEATURES**

Fully Welded Frame / Melamine Shelving / Top Included / 4 Shelves

CODE	DIMENSION
HXWDSTUT090	900W x 400D x 2000H
HXWDSTUT012	1200W x 400D x 2000H
HXWDSTUT015	1500W x 400D x 2000H
HXWDSTUT018	1800W x 400D x 2000H



**UPTOWN BUFFET**



**FEATURES**

Storage Nook / Round Tube Legs / Pull To Open Doors / 1 Shelf Included

CODE	DIMENSION	DOORS
UPBF090	900W x 400D x 900H	2
UPBF012	1200W x 400D x 900H	2
UPBF015	1500W x 400D x 900H	4
UPBF018	1800W x 400D x 900H	4

**PATHWAY STORAGE UNIT**



**FEATURES**

Birdsmouth Joins on Top / 1 Fixed Shelf / Welded Full Frame / Powdercoated Black or White / Contrast Edging

CODE	DIMENSION
PTHWYSTUT090	900W x 400D x 900H
PTHWYSTUT012	1200W x 400D x 900H

**AVERY STORAGE CUPBOARDS**



**FEATURES**

Double Door with Blade Handle OR 1 Long Door No Handle with Open Shelving and Small Cupboard / Adjustable Shelving / Render Reflects 1200W

CODE	DIMENSION	DOORS
AVST180945	900W x 450D x 1800H	1 LARGE 1 SMALL
AVST1801245	1200W x 450D x 1800H	1 LARGE 1 SMALL
AVSTTD180945	900W x 450D x 1800H	2
AVSTTD1801245	1200W x 450D x 1800H	2

**BOSLEY STORAGE UNIT**



**FEATURES**

Fully Welded Frame / Melamine Shelving with Dividers / 3 Quarter Melamine Contrast Backing / 3 Small Doors

CODE	DIMENSION	DOORS
BOSLEYSTUT1345	1500W x 350D x 2100H	3

**WELDED GARDEN LOCKERS**



**FEATURES**

Melamine Lockers / Black or White Powdercoat Finishes / Render Reflects 2 x 1200W Units

CODE	DIMENSION	NO OF DOORS
GDLK120518BL	1200W x 500D x 2100H	8

Plants Subject to Stock Availability

**RECEPTION CONSOLE**



**FEATURES**

2 Drawer / Adjustable Feet

CODE	DIMENSION	DRAWERS
RECO1240	1200W x 400D x 800H	2
RECO1540	1500W x 400D x 800H	2
RECO1840	1800W x 400D x 800H	2



# GARDEN ROOM DIVIDERS

The Planter Room Dividers were designed due to a gap in our offering for those who wanted the benefit of greenery in a workspace without the requirement for storage. Without the storage we are able to design these units in a slim line fashion, they can be used at the ends of workstations or dividing workstations, as well as breakout areas or creating corridors in an open space.



PLANTS IN RENDER ARE INDICATIVE ONLY

### GLADE PLANTER DIVIDER - NO STORAGE

#### FEATURES

No Storage / Slimline Design / Contrast Panel  
Adjustable Internal / Platter in Planter 18mm Construction

CODE	DIMENSION
GRDGL9004	900W x 300D x 1350H
GRDGL1204	1200W x 300D x 1350H
GRDGL1504	1500W x 300D x 1350H
GRDGL1804	1800W x 300D x 1350H

\*Plants Subject to Stock Availability



PLANTS IN RENDER ARE INDICATIVE ONLY

### BLAIR PLANTER DIVIDER - NO STORAGE

#### FEATURES

Birdsmouth Joins / Slimline Design / Groove Line Wrapping Around / Adjustable Internal  
Platter in Planter / 18mm Construction

CODE	DIMENSION
GRDBL9004	900W x 300D x 1350H
GRDBL1204	1200W x 300D x 1350H
GRDBL1504	1500W x 300D x 1350H
GRDBL1804	1800W x 300D x 1350H

\*Plants Subject to Stock Availability



PLANTS IN RENDER ARE INDICATIVE ONLY

### WILLOW PLANTER DIVIDER - NO STORAGE

#### FEATURES

Birdsmouth Joins / Shadowline Uplift / No Storage/ Plinth / Adjustable Internal Platter in Planter /  
18mm Construction

CODE	DIMENSION
GRDWI9004	900W x 300D x 1350H
GRDWI1204	1200W x 300D x 1350H
GRDWI1504	1500W x 300D x 1350H
GRDWI1804	1800W x 300D x 1350H

\*Plants Subject to Stock Availability



PLANTS IN RENDER ARE INDICATIVE ONLY

### GARDEN BOX ON CASTORS - NO STORAGE

#### FEATURES

Birdsmouth Joins / Heavy Duty Castors

CODE	DIMENSION
GRDGB9004	900W x 300D x 700H
GRDGB1204	1200W x 300D x 700H
GRDGB1504	1500W x 300D x 700H

\*Plants Subject to Stock Availability



The designer credenza line was intended to be minimalistic and modern with its masterpiece details such as birds-mouth joins, curved doors, soft closing hinges and uplifted bases all that have been carefully designed for the details of the commercial space. They are even more beautiful in real life once they arrive on site. Take our word for it, they are a stand out.

Please note there have been adjustments to the heights in the designer range of credenzas, now all ranging from 800mm - 850mm High. Leg colours will specify the internal carcass and Back colour. Black and White Only.

**LENA CREDENZA**

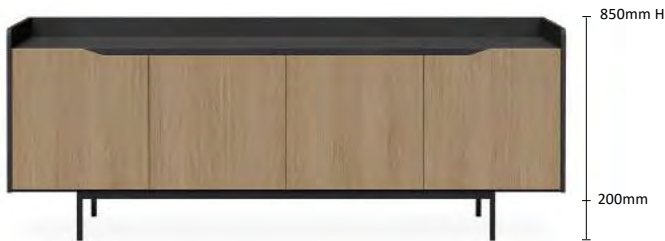

**FEATURES ABSOLUTE MATTE BLACK TOP**

Please specify Colour Finish where Wood grain is featured / Top in Absolute Matte / Round Tube Legs / 18mm Construction / All internals including back are in Black / Pull To Open Doors / Adjustable Feet

CODE	DIMENSION	DOORS
RECCRELE1504	1500W x 450D x 850H	3
RECCRELE1804	1800W x 450D x 850H	4
RECCRELE2104	2100W x 450D x 850H	4
RECCRELE2404	2400W x 450D x 850H	4

**CREDENZA - G**



**FEATURES ABSOLUTE MATTE BLACK DOOR & DRAWER FRONTS**

Please specify Colour Finish where wood grain is featured / Absolute Matte Doors and Drawers / 18mm Construction / All internals including back are in Black / Push To Open Doors

CODE	DIMENSION	DOORS
RECCREG1504	1500W x 450D x 800H	4
RECCREG1804	1800W x 450D x 800H	4
RECCREG2104	2100W x 450D x 800H	4
RECCREG2404	2400W x 450D x 800H	4

**MILA I CREDENZA**



**FEATURES PANELS**

Woodgrain Finish where featured / Black Contrast / Round Tube Legs / 18mm Construction / All internals including back are in Black / Push To Open Doors / Adjustable Feet

CODE	DIMENSION	DOORS
RECCREMI11504	1500W x 450D x 850H	3
RECCREMI11804	1800W x 450D x 850H	3
RECCREMI12104	2100W x 450D x 850H	4
RECCREMI12404	2400W x 450D x 850H	4

**MILA II CREDENZA**



**FEATURES ABSOLUTE MATTE BLACK DOORS**

Please specify Woodgrain Finish where featured / Absolute Matte Doors / Round Tube Legs / 18mm Construction / All internals including back are in Black / Push To Open Doors / Adjustable Feet

CODE	DIMENSION	DOORS
RECCREMI21504	1500W x 450D x 850H	3
RECCREMI21804	1800W x 450D x 850H	3
RECCREMI22104	2100W x 450D x 850H	4
RECCREMI22404	2400W x 450D x 850H	4

**AXIS CREDENZA**



**FEATURES GROOVED AXIS PATTERN**

When ordering Please specify Colour/ 1 Adjustable Shelf / Adjustable Feet/ Black Powdercoat Legs / All internals including back are in Black / Push To Open

CODE	DIMENSION	DOORS
RECCREAX1504	1500W x 450D x 800H	4
RECCREAX1804	1800W x 450D x 800H	4
RECCREAX2104	2100W x 450D x 800H	4
RECCREAX2404	2400W x 450D x 800H	4

**DREW CREDENZA**



**FORMERLY CREDENZA D**

When ordering Please specify Colour / Adjustable Feet / 1 Adjustable Shelf / Black Powdercoat Legs / Top Behind Doors / All internals including back are in Black / Pull To Open

CODE	DIMENSION	DOORS
RECCRED1504	1500W x 450D x 800H	4
RECCRED1804	1800W x 450D x 800H	4
RECCRED2104	2100W x 450D x 800H	4
RECCRED2404	2400W x 450D x 800H	4

**CREDENZA - H**



**FEATURES FINGER RAIL**

When ordering Please specify Colour Finish where Wood grain is featured / Horizontal Grain/ 1 Adjustable Shelf / Adjustable Feet/ Black Powdercoat Legs / All internals including back are in Black / Pull To Open

CODE	DIMENSION	DOORS
RECCREH1504	1500W x 450D x 800H	4
RECCREH1804	1800W x 450D x 800H	4
RECCREH2104	2100W x 450D x 800H	4
RECCREH2404	2400W x 450D x 800H	4

**AUSTIN CREDENZA**



**FEATURES**

When ordering Please specify Colour Finish where Wood grain is featured / 1 Adjustable Shelf / Adjustable Feet / Black Powdercoat Legs / All internals including back are in Black / Pull To Open

CODE	DIMENSION	DOORS
RECCREAU1504	1500W x 450D x 800H	4
RECCREAU1804	1800W x 450D x 800H	4
RECCREAU2104	2100W x 450D x 800H	4
RECCREAU2404	2400W x 450D x 800H	4

**ONYX CREDENZA**



**FEATURES GROOVED PATTERN**

When ordering Please specify Colour/ 1 Adjustable Shelf / Adjustable Feet/ Black Powdercoat Legs / 18mm Construction / All internals including back are in Black/ Push To Open

CODE	DIMENSION	DOORS
RECCREON1504	1500W x 450D x 800H	4
RECCREON1804	1800W x 450D x 800H	4
RECCREAU2104	2100W x 450D x 800H	4
RECCREAU2404	2400W x 450D x 800H	4

**VIDA CREDENZA**

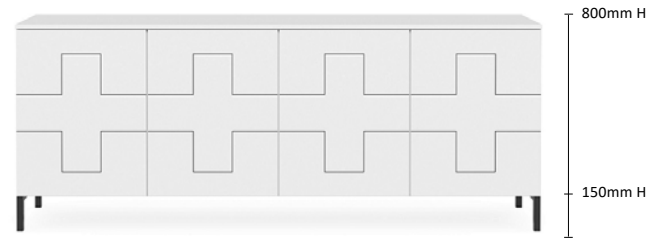

**FEATURES GROOVED PATTERN**

When ordering Please specify Colour/ 1 Adjustable Shelf / Adjustable Feet/ Back Powdercoat Legs / All internals including back are in Black / Push To Open

CODE	DIMENSION	DOORS
RECCREVI1504	1500W x 450D x 800H	4
RECCREVI1804	1800W x 450D x 800H	4
RECCREVI2104	2100W x 450D x 800H	4
RECCREVI2404	2400W x 450D x 800H	4



# STORAGE CREDENZAS

A good functional space always requires a sturdy yet good-looking credenza. In a boardroom or meeting room where furniture is at the centre of the room, a credenza adds practicality in storage and also anchors the room as a stunning showpiece.

## THE SPECTRE BAR



### FEATURES

When ordering Please specify Colour / 25mm Thick Construction / Plinth / Supply with or without Bar Fridge

## ALFIE'S BAR CREDENZA



### FEATURES

When ordering Please specify Colour / 25mm Thick Construction / Blade Handles / Supply with or without Bar Fridge

Ceiling Welded Bar Rack optional

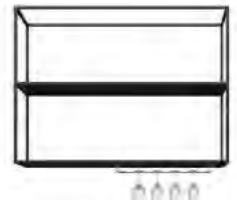

## VIBE - CREDENZA



### FEATURES UPLIFTED BASE DESIGN

When ordering Please specify Colour / 25mm Thick Construction / Adjustable Feet / Push To Open / All internals including back are in Black / Horizontal Grain

## VIBE INK LINE - CREDENZA



### FEATURES INK LINE PATTERN

When ordering Please specify Colour / 25mm Thick Construction / Adjustable Feet / Push To Open / All internals including back are in Black / Vertical Grain

CODE	DIMENSION	DOORS
RECCREVI1504	1500W x 450D x 800H	4
RECCREVI1804	1800W x 450D x 800H	4
RECCREVI2104	2100W x 450D x 800H	4
RECCREVI2404	2400W x 450D x 800H	4

CODE	DIMENSION	DOORS
RECCREVIN1504	1500W x 450D x 800H	4
RECCREVIN1804	1800W x 450D x 800H	4
RECCREVIN2104	2100W x 450D x 800H	4
RECCREVIN2404	2400W x 450D x 800H	4

**CREDENZA - A**



**FEATURES PUSH TO OPEN DOORS**

Please specify Colour / Adjustable Feet / 1 Adjustable Shelf / Push To Open Doors All internals including back are in Black

CODE	DIMENSION	DOORS
RECCREA1504	1500W x 450D x 900H	4
RECCREA1804	1800W x 450D x 900H	4
RECCREA1804	2100W x 450D x 900H	4
RECCREA1804	2400W x 450D x 900H	4

**CREDENZA - B**



**FEATURES FLOATING TOP**

Please specify Colour / Push To Open Doors / Adjustable Feet / 1 Adjustable Shelf / All internals including back are in Black

CODE	DIMENSION	DOORS
RECCREB1504	1500W x 450D x 900H	4
RECCREB1804	1800W x 450D x 900H	4
RECCREB2104	2100W x 450D x 900H	4
RECCREB2404	2400W x 450D x 900H	4

**BELLE CREDENZA**



**FEATURES 60mm UPLIFT**

Please specify Colour Finish where Wood Grain is featured / Adjustable Feet / 1 Adjustable Shelf / All internals are in White / Pull to Open Finger rail 20mm Gap

CODE	DIMENSION	DOORS
RECCREBE1504	1500W x 450D x 900H	4
RECCREBE1804	1800W x 450D x 900H	4
RECCREBE2104	2100W x 450D x 900H	4
RECCREBE2404	2400W x 450D x 900H	4

**HUDSON - CREDENZA**



**FEATURES FINGER RAIL**

Please specify Colour/ Adjustable Feet / 1 Adjustable Shelf / All internals including back are in Black / Horizontal Grain

CODE	DIMENSION	DOORS
RECCREHU1504	1500W x 450D x 900H	4
RECCREHU1804	1800W x 450D x 900H	4
RECCREHU2104	2100W x 450D x 900H	4
RECCREHU2404	2400W x 450D x 900H	4

**CREDENZA - F**



**FEATURES TWO TIER DESIGN**

When ordering Please specify Colour Finish where Wood grain is featured / Adjustable Feet / 1 Adjustable Shelf in side cupboards / Pull To Open / All internals including back are in Black

CODE	DIMENSION	DOORS
RECCREF1504	1500W x 450D x 900H	4
RECCREF1804	1800W x 450D x 900H	4
RECCREF2104	2100W x 450D x 900H	4
RECCREF2404	2400W x 450D x 900H	4

**CREDENZA - C**



**FEATURES OPEN CAVITY STORAGE**

When ordering Please specify Colour Finish where Wood grain is featured / Adjustable Feet / Pull To Open / Divider Included for Support / All internals including back are in Black

CODE	DIMENSION	DOORS
RECCREC1504	1500W x 450D x 900H	4
RECCREC1804	1800W x 450D x 900H	4
RECCREC2104	2100W x 450D x 900H	4
RECCREC2404	2400W x 450D x 900H	4

**CREDENZA A - LOW STORAGE**



**FEATURES**

Push To Open Doors / Desk Height 725H / 1 Adjustable Shelf / Adjustable Feet / All internals including back are in Black

CODE	DIMENSION	DOORS
RECCREAL090	900 W x 450D x 725H	2
RECCREAL012	1200 W x 450D x 725H	2
RECCREAL015	1500 W x 450D x 725H	4
RECCREAL018	1800 W x 450D x 725H	4
RECCREAL021	2100 W x 450D x 725H	4
RECCREAL024	2400 W x 450D x 725H	4

**CREDENZA B - LOW STORAGE**



**FEATURES FLOATING TOP**

Push To Open Doors / Desk Height 725H / 1 Adjustable Shelf / Adjustable Feet / All internals including back are in Black

CODE	DIMENSION	DOORS
RECCREBL090	900 W x 450D x 725H	2
RECCREBL012	1200 W x 450D x 725H	2
RECCREBL015	1500 W x 450D x 725H	4
RECCREBL018	1800 W x 450D x 725H	4
RECCREBL021	2100 W x 450D x 725H	4
RECCREBL024	2400 W x 450D x 725H	4

**CREDENZA C LOW STORAGE**



**FEATURES CAVITY STORAGE**

Pull Open Doors / Desk Height 725H / 1 Adjustable Shelf / Adjustable Feet/ All internals including back are in Black

CODE	DIMENSION	DOORS
RECCRECL090	900 W x 450D x 725H	2
RECCRECL012	1200 W x 450D x 725H	2
RECCRECL015	1500 W x 450D x 725H	4
RECCRECL018	1800 W x 450D x 725H	4
RECCRECL021	2100 W x 450D x 725H	4
RECCRECL024	2400 W x 450D x 725H	4

**HUDSON - LOW STORAGE**



**FEATURES FINGER RAIL**

Pull Open Doors / Desk Height 725H / 1 Adjustable Shelf / Adjustable Feet / All internals including back are in Black

CODE	DIMENSION	DOORS
RECCREHUL090	900 W x 450D x 725H	2
RECCREHUL012	1200 W x 450D x 725H	2
RECCREHUL015	1500 W x 450D x 725H	4
RECCREHUL018	1800 W x 450D x 725H	4
RECCREHUL021	2100 W x 450D x 725H	4
RECCREHUL024	2400 W x 450D x 725H	4

**CREDENZA A - WITH HANDLES**



**FEATURE STEALTH HANDLES**

PLEASE SPECIFY HANDLES / Desk Height 725H / 1 Adjustable Shelf / Adjustable Feet / All internals including back are in Black

CODE	DIMENSION	DOORS
RECCREALH90	900 W x 450D x 725H	2
RECCREALH12	1200 W x 450D x 725H	2
RECCREALH15	1500 W x 450D x 725H	4
RECCREALH18	1800 W x 450D x 725H	4
RECCREALH21	2100 W x 450D x 725H	4
RECCREALH24	2400 W x 450D x 725H	4

**BELLE - LOW STORAGE**



**FEATURES UPLIFT SIDES**

Pull Open Doors / Desk Height 725H / 1 Adjustable Shelf / Adjustable Feet / All internals are in White / Finger rail 20mm Gap

CODE	DIMENSION	DOORS
RECCREBEL090	900 W x 450D x 725H	2
RECCREBEL012	1200 W x 450D x 725H	2
RECCREBEL015	1500 W x 450D x 725H	4
RECCREBEL018	1800 W x 450D x 725H	4
RECCREBEL021	2100 W x 450D x 725H	4
RECCREBEL024	2400 W x 450D x 725H	4



**FLOATING WALL CREDENZA - FL 01**



**FEATURES**

Please specify Colour / Drawers / Pull Open From Bottom / Birdsmouth Joins / Slimline Shadowline

CODE	DIMENSION	DRAWERS
FLOC115	1500W x 350D x 200H	3
FLOC1158	1800W x 350D x 200H	3
FLOC121	2100W x 350D x 200H	4
FLOC124	2400W x 350D x 200H	4

**FLOATING WALL CREDENZA - FL 02**



**FEATURES**

Please specify Colour / Pull To Open

CODE	DIMENSION	DOORS
FLOC0215	1500W x 350D x 400H	3
FLOC0218	1800W x 350D x 400H	3
FLOC0221	2100W x 350D x 400H	4
FLOC0224	2400W x 350D x 400H	4

**FLOATING WALL CREDENZA - FL 03**



**FEATURES**

Please specify Colour / Uplift 150mm and 200mm off the floor 950mmH overall / Pull To Open / Finger Rail

CODE	DIMENSION	DOORS
FLOC0315	1500W x 350D x 600H	3
FLOC0318	1800W x 350D x 600H	3
FLOC0321	2100W x 350D x 600H	4
FLOC0324	2400W x 350D x 600H	4

**FLOATING WALL CREDENZA - FL 04**



**FEATURES**

Please specify Colour / Birdsmouth / Finger Rail / Pull To Open / 1 Adjustable Shelf

CODE	DIMENSION	DOORS
FLOC0415	1500W x 350D x 600H	4
FLOC0418	1800W x 350D x 600H	4
FLOC0421	2100W x 350D x 600H	6
FLOC0424	2400W x 350D x 600H	6

**FLOATING WALL CREDENZA - FL 05**



**FEATURES**

When ordering Please specify Colour / Push To Open/ Birdsmouth Joins / 1 Adjustable Shelf

CODE	DIMENSION	DOORS
FLOC0509	900W x 250D x 700H	2
FLOC0512	1200W x 250D x 700H	3

**FLOATING WALL CREDENZA - FL 06**



**FEATURES**

When ordering Please specify Colour / Top Over Sides / Push To Open Doors

CODE	DIMENSION	DOORS
FLOC0615	1500W x 350D x 450H	3
FLOC0618	1800W x 350D x 450H	4
FLOC0621	2100W x 350D x 450H	4
FLOC0624	2400W x 350D x 450H	6



# SIT/STAND EXECUTIVE DESKS

## GEO EXECUTIVE DESK - 101 SELECTRIC

The Geo Selectric is considered the mother ship of the Geo Series. Its new and improved design features a two level return, and signature Geo lines, making it the fully ergonomic sit/ stand desk.

GEO Executive Desk Back view



OPTION 1

OPTION 2

HEIGHT ADJUST INCLUDED TOP // 650 - 1300H

Includes desk with 101 selectric frame, cable basket, 4 GPO & DATA outlets, underdesk cord snake & 3 metre lead

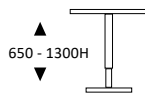

\*Mobile Pedestal Options (for Empty Return Only): Refer to page 38

CODE	DESK	EMPTY RETURN
GEOSLEX20091905	(2000L x 900D) x (2100L x 550D)	
RETURN OPTION 1	Floating Drawer System	
RETURN OPTION 2	1 + File & Adjustable shelves	



2000mm

(Image shown as a left hand return)

Finish Options: **46 Standard Colours**  
Rectangular Cable Hole to your preferred placement (included)

## ID EXECUTIVE DESK - 101 SELECTRIC

The "ID" is as unique as you are. Designed entirely as the complete ergonomic solution, with a robust and bold aesthetic.



OPTION 1

OPTION 2

Image shown with Optional Concealed Power Access Door

HEIGHT ADJUST INCLUDED TOP // 650 - 1300H

Includes desk with 101 selectric frame, cable basket, 4 GPO & DATA outlets, underdesk cord snake & 3 metre lead

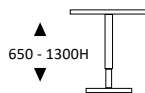

\*Mobile Pedestal Options (for Empty Return Only): Refer page 38

CODE	DESK	EMPTY RETURN
IDEXE22092205	(2200L x 900D) x (2100L x 550D)	
RETURN OPTION 1	Floating Drawer System	
RETURN OPTION 2	1 + File & Adjustable shelves	

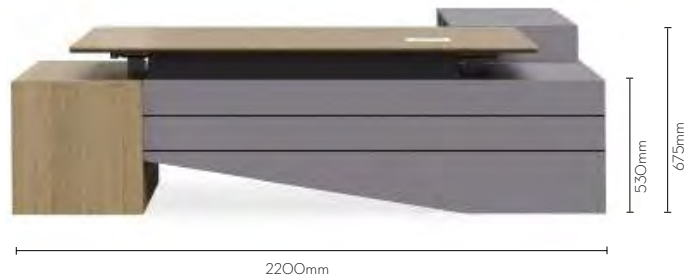

2200mm

(Image shown as a left hand return)

Finish shown: Natural Walnut + Charcoal + Tile lines + Sharknosed Front Panel  
Finish Options: **46 Standard Colours**  
Rectangular Cable Hole to your preferred placement (included)



# DESIGNER DESKS

## OUTLINER DESK

### FEATURES

25mm Construction /Cable Hole Included /Uplifted Shadow Line



CODE	DIMENSION
OUTLNSK1809	1800L x 900D x 725H
OUTLNSK2109	2100L x 900D x 725H

## OUTLINER RETURN DESK

### FEATURES

25mm Construction /Cable Hole Included /Uplifted Shadow Line



Top view

( Image shown left side return)



CODE	DESK	RETURN
OUTLNRT0905	(1800L x 900D) x (900L x 550D) x 725H	
OUTLNRT1205	(2100L x 900D) x (1200L x 550D) x 725H	

## ATLAS EXECUTIVE DESK

### FEATURES

Atlas is a piece that sets the tone of professionalism and style in any office. The new look privacy panel is at the forefront of its features, that sets it apart with a detailed panel end leg that ties it all together.



Privacy Panel Laminex Manhattan

CODE	DIMENSION
ATLSDSK1809	1800L x 900D x 725H
ATLSDSK2109	2100L x 900D x 725H

## VAULT EXECUTIVE DESK

### FEATURES

Has a backbone of its own, with its blunt strong straight forward lines and wrap around panel makes this executive desk an elite and elegant piece.



CODE	DESK	RETURN
VLTDSK180907	(1800L x 900D) x (900L x 550D) x 725H	
VLTDSK211207	(2100L x 900D) x (1200L x 550D) x 725H	



# TWO TIER EXECUTIVE DESK

## TWO TIER EXECUTIVE DESK

A new range of executive combinations with four different leg styles and possible buffet/return options. Perfect for both the executive and home office alike.

**Finish Options: Standard 46 Colours**

### 2 TIER STORAGE EXECUTIVE DESK



- 1 Small Door + 2 Drawers + 1 File
- 3 Cupboards
- 1 Tall Cupboard
- Push Open System

CODE	DESK	BUFFET & STORAGE	STYLE
EXDSKC1818SC	(2100L x 900D)	x (1813L x 550D) x 900H	3 Doors + 1 Storage



- 1 Small Door + 1 Drawers + 1 File
- 4 Cupboards
- 1 Tall Cupboard
- Push Open System

CODE	DESK	BUFFET & STORAGE	STYLE
EXDSKC2222SC	(2100L x 900D)	x (2263L x 550D) x 900H	4 Doors + 1 Storage



Leto base shown as right hand return

### TABLE LEG OPTIONS

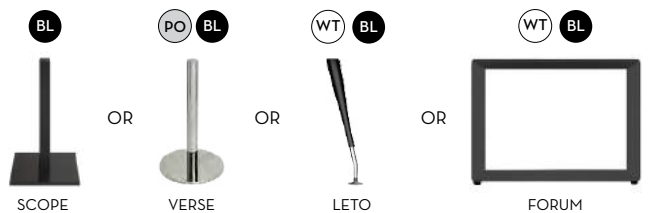



# TAILOR EXECUTIVE DESK

## TAILOR EXECUTIVE DESK

A new range of executive combinations with four different leg styles and possible buffet/return options. Perfect for both the executive and home office alike.

**Finish Options: Standard 46 Colours**

### TAILOR EXECUTIVE DESK



- 2 Drawers + 1 File
- 3 Cupboards
- Open Unit
- Push Open System

CODE	DESK	BUFFET & STORAGE	STYLE
EXDSKA1818SC	(1800L x 900D) x (1813L x 550D) x 725H		2 Doors + 1 Storage



- 2 Drawers + 1 File
- 4 Cupboards
- Open Unit
- Push Open System

CODE	DESK	BUFFET & STORAGE	STYLE
EXDSKA2222SC	(2250L x 900D) x (2263L x 550D) x 725H		3 Doors + 1 Storage



Shown as LHS hand return

### TABLE LEG OPTIONS

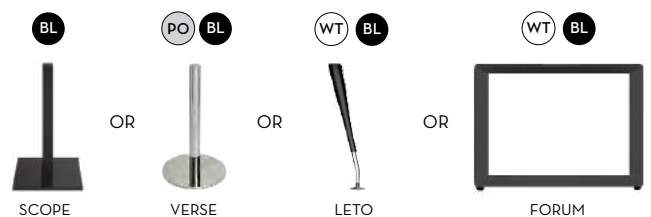



Minimalist Design for the Contemporary office, simple yet stunning. The Geo Range is a standout design, for any executive office, customizable to fit your space and available in a choice of 46 Colours, made from Local EO board.

**ENVOY DESK (Overhang Top)**

Envoy desk is aesthetically pleasing yet practical as a working desk inviting for visitors with overhang feature.

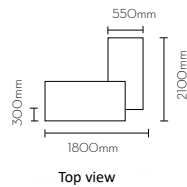

(Images shown as a left hand return)

Finish Options: **Colour swatches page 87 (EO Board)**  
Rectangular Cable Hole to your preferred placement (included)

CODE	DESK	RETURN
ENVEX1805	(1800L x 900D) x	(1800L x 550D) x 725H
ENVEX2105	(2100L x 900D) x	(2100L x 550D) x 725H

**GEO SLAB END DESK (Flush at the Front)**

The GEO Slab End still with feature tile-lines on the return undercarriage and customizable to fit your space.

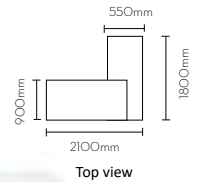

2100mm

(Images shown as a left hand return)

Finish Options: **Colour swatches page 87 (EO Board)**  
Cable Hole to your preferred placement (included)

CODE	DESK	RETURN
GEOSLABEX21091805	(2100L x 900D) x	(1800L x 550D) x 725H
GEOSLABEX24091805	(2400L x 900D) x	(1800L x 550D) x 725H

**Underdesk Mobile Pedestal Options**

\*Suitable for Envoy, ID Desk & GEO Range



Metal Pedestal  
390W x 500D x 595H  
4 Colour Options - **page 68**

OR



1 Drawer Pedestal  
410W x 505D x 590H  
Lock Options: **Page 85**  
Finish Options - **Page 87**

OR



Melamine Pedestal  
410W x 505D x 500H  
Lock Options: **Page 85**  
Finish Options - **page 87**

**GEO FORUM**



(Image shown as a left hand return)

Base Finish: White / Black  
 Finish Options: **Standard 46 Colours**  
 Cable Hole to your preferred placement (included)

CODE	DESK	RETURN
GEOFRMEX21092005	(2100L x 900D) x (1800L x 550D) x 725H	
GEOFRMEX24092005	(2400L x 900D) x (1800L x 550D) x 725H	

**GEO LETO**



(Image shown as a left hand return)

Base Finish: White / Black  
 Finish Options: **Standard 46 Colours**  
 Cable Hole to your preferred placement (included)

CODE	DESK	RETURN
GEOLTOEX21092005	(2100L x 900D) x (1800L x 550D) x 725H	
GEOLTOEX24092005	(2400L x 900D) x (1800L x 550D) x 725H	

**GEO VISTA**



(Image shown as a left hand return)

Base Finish: White / Black  
 Finish Options: **Standard 46 Colours**  
 Cable Hole to your preferred placement (included)

CODE	DESK	RETURN
GEOVISEX21092005	(2100L x 900D) x (1800L x 550D) x 725H	
GEOVISEX24092005	(2400L x 900D) x (1800L x 550D) x 725H	

**GEO SCOPE**



(Image shown as a left hand return)

Base Finish: Black  
 Finish Options: **Standard 46 Colours**  
 Cable Hole to your preferred placement (included)

CODE	DESK	RETURN
GEOSCOPEX21092005	(2100L x 900D) x (1800L x 550D) x 725H	
GEOSCOPEX24092005	(2400L x 900D) x (1800L x 550D) x 725H	

**GEO VERSE**

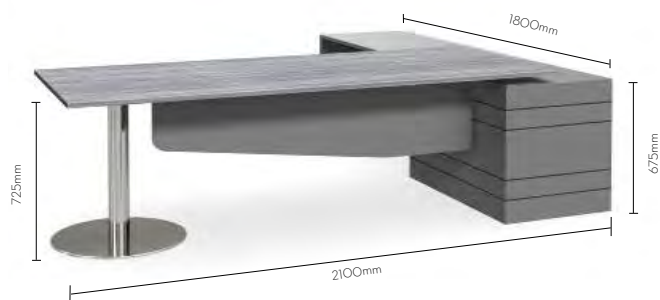

(Image shown as a left hand return)

Base Finish: Polished Stainless Steel / Black  
 Finish Options: **Standard 46 Colours**  
 Cable Hole to your preferred placement (included)

CODE	DESK	RETURN
GEOVEREX21092005	(2100L x 900D) x (1800L x 550D) x 725H	
GEOVEREX24092005	(2400L x 900D) x (1800L x 550D) x 725H	

**GEO Desk back view**

- 1 Open unit + Shelf
- Open space for Underdesk Pedestal ( Add your Pedestal of Choice below )



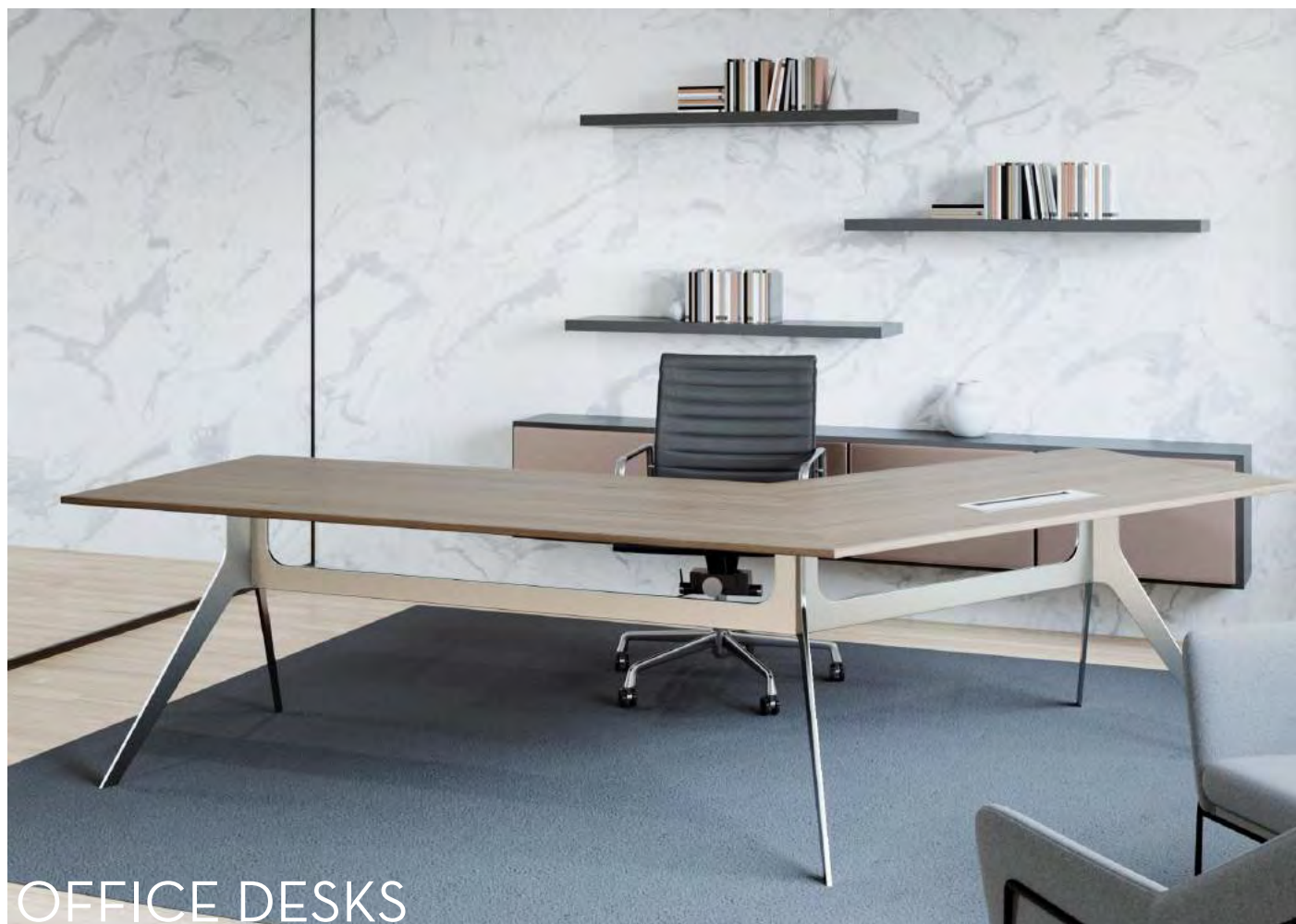

# OFFICE DESKS

These Office Desks are a light range of executive desks, offering a unique executive designed look as well as the workplaces with limited space and little requirement for storage.

## DELTA 120

### FEATURES

Frame Finish in Polished Steel / Top 25mm Thickness  
 Rectangle Cable Outlet Included (Top Finish Options: Standard 46 Colours)



CODE	DESK	RETURN
DELWS15071506	(1500L x 750D) x (1500L x 750D) x 750H	
DELWS18071506	(1800L x 750D) x (1500L x 750D) x 750H	
OPTION	2 Melamine Modesty Panels 130H	

## DELTA

### FEATURES

Frame Finish in Black/ Top 25mm Thickness  
 / Modesty Option (Top Finish Options: Standard 46 Colours)



CODE	DIMENSION
DNVEX1807	1800L x 750D x 750H
DNVEX2109	2100L x 900D x 750H
OPTION	Melamine Modesty Panel 130H

## CLDE - CC PLUS DESK

### FEATURES

25mm Construction  
 Cable Hole Included  
 Standard 46 Colours



CODE	OVERALL SIZE
CLDE1507	1500L x 750D x 725H
CLDE1807	1800L x 750D x 725H

## CC PLUS DESK WITH RETURN

### FEATURES

25mm Construction  
 Cable Hole Included  
 Standard 46 Colours

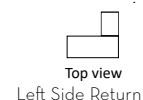

CODE	DESK	RETURN
CLDECLFRE1507	(1500L x 750D) x (1500L x 600D) x 725H	
CLDECLFRE1807	(1800L x 750D) x (1800L x 600D) x 725H	
CLDECLFRE1809	(1800L x 900D) x (1800L x 600D) x 725H	



### PLAZA DESK

**FEATURES**

Frame Finish in Black or White/ Top 25mm Thickness  
Cable Hole Included  
Top Finish Options: Standard 46 Colours

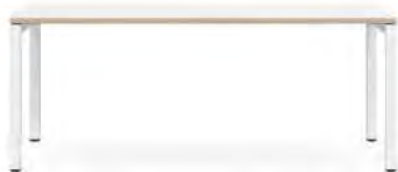

CODE	OVERALL SIZE
PLZDES1507	1500L x 750D x 725H
PLZDES1807	1800L x 750D x 725H

### PLAZA DESK WITH RETURN

**FEATURES**

Frame Finish in Black or White/ Top 25mm Thickness  
Cable Hole Included / Modesty Panel Black or White  
Top Finish Options: Standard 46 Colours

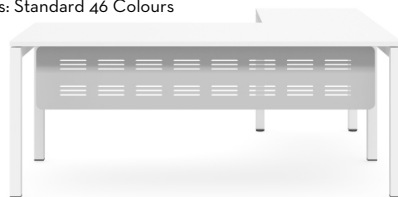
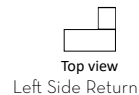

CODE	DESK	RETURN
PLZWS18071806	(1800L x 750D)	(1800L x 600D) x 725H
PLZWS18091806	(1800L x 900D)	(1800L x 600D) x 725H

### FORUM DESK

**FEATURES**

Frame Finish in Black or White/ Top 25mm Thickness  
Cable Hole Included  
Top Finish Options: Standard 46 Colours

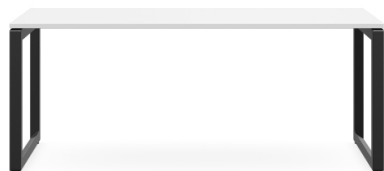

CODE	OVERALL SIZE
FORDES1507	1500L x 750D x 725H
FORDES1807	1800L x 750D x 725H

### FORUM DESK WITH RETURN

**FEATURES**

Frame Finish in Black or White/ Top 25mm Thickness  
Cable Hole Included / Modesty Panel Black or White  
46 Standard Colours for Top

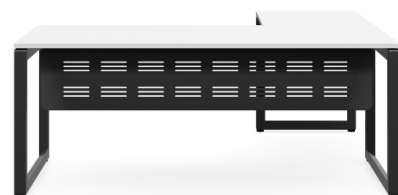
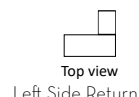

CODE	DESK	RETURN
FORWS18071806	(1800L x 750D)	(1800L x 600D) x 725H
FORWS18091806	(1800L x 900D)	(1800L x 600D) x 725H

### FORUM LITE

**FEATURES**

Frame Finish in Black or White/ Top 25mm Thickness  
Cable Hole Included  
46 Standard Colours



CODE	DIMENSION
FORDLI1507	1500L x 750D x 725H
FORDLI1807	1800L x 750D x 725H
FORDLI2109	2100L x 900D x 725H

### FORUM LITE - WITH RETURN

**FEATURES**

Frame Finish in Black or White/ Top 25mm Thickness  
Cable Hole Included / Modesty Panel  
46 Standard Colours

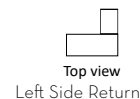

CODE	DIMENSION
FORDLIRT1507	1500L x 750D x (1500L x 600D) x 725H
FORDLIRT1807	1800L x 750D x (1800L x 600D) x 725H
FORDLIRT2109	2100L x 900D x (2100L x 600D) x 725H

### VISTA DESK

**FEATURES**

Frame Finish in Black or White/ Top 25mm Thickness  
Cable Hole Included  
46 Standard Colours for top

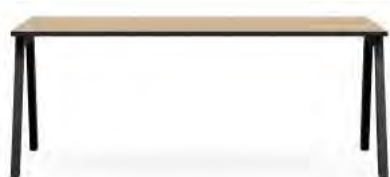

CODE	OVERALL SIZE
VISDES1509	1500L x 900D x 725H
VISDES1809	1800L x 900D x 725H

### VISTA LITE - WITH RETURN

**FEATURES**

Frame Finish in Black or White/ Top 25mm Thickness  
Cable Hole Included / Modesty Panel  
46 Standard Colours

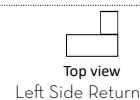

CODE	OVERALL SIZE
VISRTLITE1809	2100L x 900D x (2100L x 600D) x 725H



# BOARDROOM TABLES

First impressions are everything when running your business and your board room is one of the most crucial rooms in your office space. With interviews conducted, meetings held, and problems being resolved, you need a professional looking space to help increase the productivity of your business.

**Top Finish Options: Standard 46 Colours**

### TOP SHAPES OPTIONS

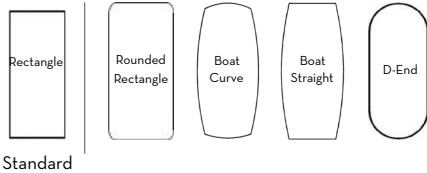

Standard

### SHARK NOSE OPTION

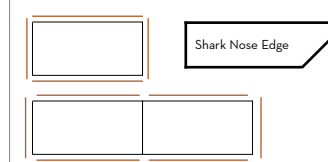

### POWER DOCK OPTION



- 2 GPO + 3 DATA:
- 4 GPO + 5 DATA:

- Finish Options:  
**Black / Silver / White**

Includes Starter Lead with 10 AMP Plug

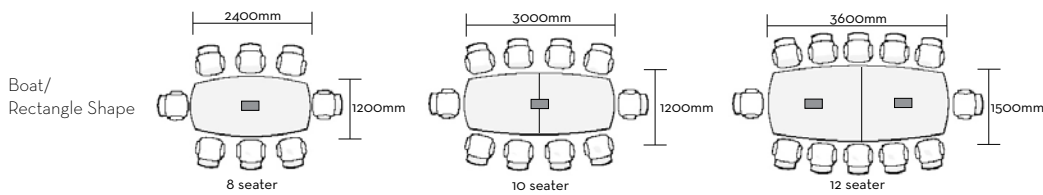

Cable Management Box with Door substitute for extra legs (applicable for 3 meter plus)

### SURROUND BOARDROOM TABLE

#### FEATURES

Custom Made / Featuring the New Laminex Surround Product this base painted in standard paint colours and matched with our 46 Standard Colour 25mm Top

### OKTO BOARDROOM TABLE

#### FEATURES

Custom Made / 25mm Construction / Square Corners



CODE	DIMENSION
OKTOBRDMTB2412	2400L x 1200D x 750H

**EMPIRE BOARDROOM TABLE****FEATURES**

A cross over box base design / Rounded Corners / 25mm Construction / More Sizes Available / Power Docks **optional**



CODE	DIMENSION
EMPIREBRDRMTB3615	3600L x 1500D x 750H

**ORLANDO BOARDROOM TABLE****FEATURES**

Laminated curved base with top insert in D End Top / More Sizes Available / Limited Colours Available / Power Docks **optional**



CODE	DIMENSION
ORLNDOBRDRMTB3615	3600L x 1500D x 750H

**REX BOARDROOM TABLE****FEATURES**

Lap Joins on rectangle column legs joined by slimline modesty panel / 25mm Construction / Square Corners / More Sizes Available



CODE	DIMENSION
REXBRDRMTB3615	3600L x 1500D x 750H

**ASA BOARDROOM TABLE****FEATURES**

25mm Construction / Rounded Corners / More Sizes Available



CODE	DIMENSION
ASABRDMTB2412	2400L x 1200D x 750H

**LUXOR BOARDROOM TABLE****FEATURES**

Laminated Semi Curved Bases / More Sizes Available / Discrete Modesty Panel / Limited Colours Available / D End Top



CODE	DIMENSION
LUXORBRDRMTB2412	2400L x 1200D x 750H

**AXEL BOARDROOM TABLE****FEATURES**

25mm Construction / Square Corners / More Sizes Available



CODE	DIMENSION
AXELBRDMTB2412	2400L x 1200D x 750H



# BOARDROOM TABLES

A boardroom can say a lot about a business, that's why we offer a range of boardroom tables to suit any style, combination or purpose. Our range does not stop here; we offer custom solutions.

## HARBOUR BOARDROOM TABLE

### FEATURES

Heavy Duty Steel Frame / 25mm Thick Top / Square Corners



CODE	DIMENSION
HARBOURBRDMTB3615	3600L x 1500D x 750H

## REMY BOARDROOM TABLE

### FEATURES

25mm Steel Tube Construction / 25mm Top / Adjustable Feet



CODE	DIMENSION
REMYBRDMTB2412	2400L x 1200D x 750H

## KOVA BOARDROOM TABLE

### FEATURES

75mm x 75mm Tube Legs / 25mm Thick Top / Square Corners



CODE	DIMENSION
KOVABRMTB2412	2400L x 1200D x 750H

## ARRO BOARDROOM TABLE

### FEATURES

D End Top / 46 Standard Colours



CODE	DIMENSION
ARROBRDMTB3615	3600L x 1500D x 750H

### APOLLO BOARDROOM TABLE POLISHED STEEL

Frame Finish: Polished Steel  
 Top Colour Choice 46 Standard Colours  
 25mm Thick Top / 3600mm long and above is two piece top  
 (\*) Power Dock cannot be centered in Top due to extra legs



CODE	DIMENSION	LEG
IMAPBTB2109	2100L x 1200D x 750H	4
IMAPBTB2412	2400L x 1200D x 750H	4
IMAPBTB2712	2400L x 1500D x 750H	4
IMAPBTB3012	3000L x 1200D x 750H (*)	6
IMAPBTB3615	3600L x 1500D x 750H (*)	6

### APOLLO BOARDROOM TABLE - BLACK

Frame Finish: Powder-coated Black  
 Top Colour Choice 46 Standard Colours  
 25mm Thick Top / 3600mm long and above is two piece top  
 (\*) Power Dock cannot be centered in Top due to extra legs



CODE	DIMENSION	LEG
IMAPBTBBL2109	2100L x 1200D x 750H	4
IMAPBTBBL2412	2400L x 1200D x 750H	4
IMAPBTBBL2712	2400L x 1500D x 750H	4
IMAPBTBBL3012	3000L x 1200D x 750H (*)	6
IMAPBTBBL3615	3600L x 1500D x 750H (*)	6

### TORO BOARDROOM TABLE

Frame Finish: Powdercoat Black  
 Top Colour Choice 46 Standard Colours  
 25mm Thick Top / 3600mm long and above is two piece top  
 (\*) Power Dock cannot be centered on Top due to extra legs



CODE	DIMENSION	LEG
TOBRDTB2109	2100L x 900D x 750H	4
TOBRDTB2412	2400L x 1200D x 750H	4
TOBRDTB2712	2700L x 1200D x 750H	4
TOBRDTB3012	3000L x 1200D x 750H (*)	6
TOBRDTB3615	3600L x 1500D x 750H (*)	6

### KATO BOARDROOM TABLE

Frame Finish: Polished Steel  
 Top Colour Choice 46 Standard Colours  
 25mm Thick Top / 3600mm long and above is two piece top

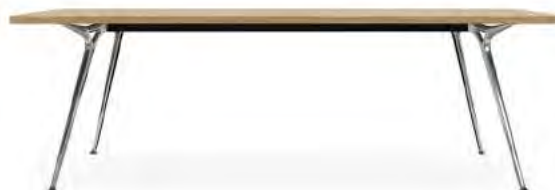

CODE	DIMENSION	LEG
KTBRDTB2109	2100L x 900D x 750H	4
KTBRDTB2412	2400L x 1200D x 750H	4
KTBRDTB2712	2700L x 1200D x 750H	4
KTBRDTB3012	3000L x 1200D x 750H (*)	6
KTBRDTB3615	3600L x 1500D x 750H (*)	6

### LETO BOARDROOM TABLE - WHITE

Frame Height: 725 - 825 (H)  
 Base Finish: White  
 25mm Thick Top / 3600mm long and above is two piece top



CODE	DIMENSION	LEG
LEBRDTB2109	2100L x 900D x 725~825H	4
LEBRDTB2412	2400L x 1200D x 725~825H	4
LEBRDTB2712	2700L x 1200D x 725~825H	4
LEBRDTB3012	3000L x 1200D x 725~825H (*)	6
LEBRDTB3615	3600L x 1500D x 725~825H (*)	6

### LETO BOARDROOM TABLE - BLACK

Frame Height: 725 - 825 (H)  
 Base Finish: Black  
 25mm Thick Top / 3600mm long and above is two piece top



CODE	DIMENSION	LEG
LEBRDTB2109	2100L x 900D x 725~825H	4
LEBRDTB2412	2400L x 1200D x 725~825H	4
LEBRDTB2712	2700L x 1200D x 725~825H	4
LEBRDTB3012	3000L x 1200D x 725~825H (*)	6
LEBRDTB3615	3600L x 1500D x 725~825H (*)	6



# BOARDROOM TABLES

## SUPREME BOARDROOM TABLE

Frame Finish: Polished Steel  
 Top Colour Choice 46 Standard Colours  
 25mm Thick Top



CODE	DIMENSION	LEG
IMSU1BA2109	2100L x 900D x 725H	2
IMSU1BA2412	2400L x 1200D x 725H	2
IMSU1BA2712	2700L x 1200D x 725H	2
IMSU1BA3012	3000L x 1200D x 725H	2

## DUO SCOPE BOARDROOM TABLE

Base Finish: Powdercoat Black  
 Top Colour Choice 46 Standard Colours  
 25mm Thick Top



CODE	DIMENSION	LEG
DISBRDTBL2412	1800L x 900D x 745H	2
DISBRDTBL3015	2100L x 900D x 745H	2
DISBRDTBL3615	2400L x 1200D x 745H	2

## DUO VERSE BOARDROOM TABLE - BLACK

Base Finish: Powdercoat Black  
 Top Colour Choice 46 Standard Colours  
 25mm Thick Top Curved



CODE	DIMENSION	LEG
DUOVRSDBL2109	1800L x 900D x 745H	2
DUOVRSDBL2412	2100L x 900D x 745H	3
DUOVRSDBL2712	2400L x 1200D x 745H	3

## DUO VERSE BOARDROOM TABLE - POLISHED

Frame Finish: Polished Steel  
 Top Colour Choice 46 Standard Colours  
 25mm Thick Top Curved



CODE	DIMENSION	LEG
DUOVRSD1809	1800L x 900D x 745H	2
DUOVRSD2109	2100L x 900D x 745H	2
DUOVRSD2412	2400L x 1200D x 745H	2

**DELTA NOUVEAU SOLO - BLACK**

Base Finish: Black  
( 25mm Rectangle Top Shown )



More sizes available please contact customer service

CODE	DIMENSION	LEG
IMDND2B2109	2100L x 900D x 750H	4
IMDND2B2412	2400L x 1200D x 750H	4
IMDND2B2712	2700L x 1200D x 750H	4

**DELTA NOUVEAU SOLO - POLISHED**

Base Finish: Polished Stainless Steel  
( 25mm Rectangle Top Shown )



More sizes available please contact customer service

CODE	DIMENSION	LEG
IMDND2B2109	2100L x 900D x 750H	4
IMDND2B2412	2400L x 1200D x 750H	4
IMDND2B2712	2700L x 1200D x 750H	4

**DELTA NOUVEAU TRIPLE - BLACK**

(\*) Power Dock cannot be centered on Top due to extra legs  
Base Finish: Black  
( 25mm Rectangle Top Shown ) / 3600mm long and above is two piece top



More sizes available

CODE	DIMENSION	LEG
IMDND2B3012	3000L x 1200D x 750H	6
IMDND2B3612	3600L x 1200D x 750H	6
IMDND2B4212	4200L x 1200D x 750H	6

**DELTA NOUVEAU TRIPLE - POLISHED**

(\*) Power Dock cannot be centered on Top due to extra legs  
Base Finish: Polished Stainless Steel  
( 25mm Rectangle Top Shown ) / 3600mm long and above is two piece top



More sizes available

CODE	DIMENSION	LEG
IMDND3B3012	3000L x 1200D x 750H	6
IMDND2B2412	3600L x 1200D x 750H	6
IMDND2B4212	4200L x 1200D x 750H	6

**DELTA NOUVEAU DUO - BLACK**

Base Finish: Black  
( 25mm Rectangle Top Shown )



More sizes available please

CODE	DIMENSION	LEG
IMDND1BBL1815	1800L x 1500D x 750H	4
IMDND1BBL2415	2400L x 1500D x 750H	4
IMDND1BBL2118	2100L x 1800D x 750H	4
IMDND1BBL2418	2400L x 1800D x 750H	4

**DELTA NOUVEAU DUO - POLISHED**

Base Finish: Polished Stainless Steel  
( 25mm Rectangle Top Shown )



More sizes available

CODE	DIMENSION	LEG
IMDND1B1815	1800L x 1500D x 750H	4
IMDND1B2415	2400L x 1500D x 750H	4
IMDND1B2118	2100L x 1800D x 750H	4
IMDND1B2418	2400L x 1800D x 750H	4

**DELTA NOUVEAU DUO TWIN - BLACK**

Base Finish: Black  
( 25mm Rectangle Top Shown ) 3600mm long and above is two piece top  
(\*) Power Dock cannot be centered on Top due to extra legs



More sizes available

CODE	DIMENSION	LEG
IMDND2BBL3015	3000L x 1500D x 750H	6
IMDND2BBL4215	4200L x 1500D x 750H	6
IMDND2BBL3018	3000L x 1800D x 750H	6
IMDND2BBL4218	4200L x 1800D x 750H	6

**DELTA NOUVEAU DUO TWIN - POLISHED**

Base Finish: Polished Stainless Steel  
( 25mm Rectangle Top Shown ) 3600mm long and above is two piece top  
(\*) Power Dock cannot be centered on Top due to extra legs



More sizes available

CODE	DIMENSION	LEG
IMDND2B3015	3000L x 1500D x 750H	6
IMDND2B4215	4200L x 1500D x 750H	6
IMDND2B3018	3000L x 1800D x 750H	6
IMDND2B4218	4200L x 1800D x 750H	6



# BREAKOUT/MEETING TABLES

We offer you elegant functional frames in all sizes and styles in meeting and training tables. We will have the right solution for your needs. Training room tables need elbow room as well as space to move around the room with ease.

## TOP SHAPES OPTIONS

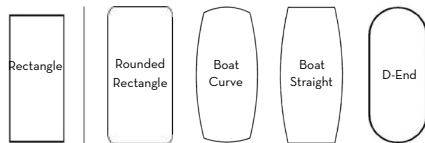

Standard

## SHARK NOSE OPTION

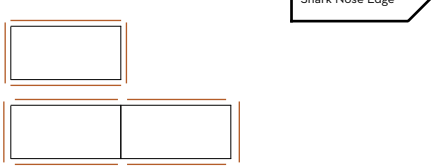

## POWER DOCK OPTION



- 2 GPO + 3 DATA:
- 4 GPO + 5 DATA:
- Finish Options: Black / Silver / White

\*Includes Starter Lead with to AMP Plug

## CONFIGURATIONS HOST FLIP TABLES

Host Flip Tables can be used in several combinations

Configurations are a guide only

When ordering in a woodgrain with obvious grain pattern **Please note** they cannot always match the grain when in certain combinations

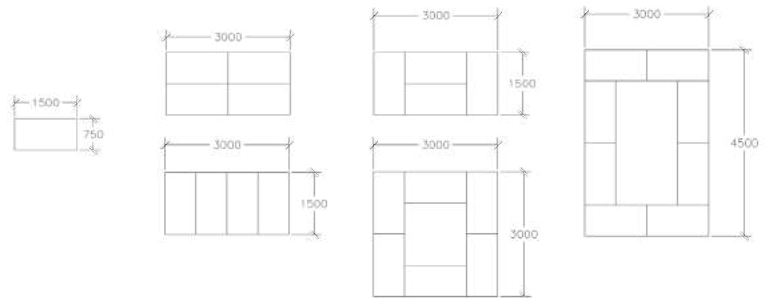

## HOST FLIP TABLE

Base Finish: Black + Silver / All Black  
Top Finish: 46 Standard Colours



## ASA MEETING TABLE ROUND

46 Standard Colours



CODE	DIMENSION
IMHOFTB15	1500W x 750D x 725H
IMHOFTB18	1800W x 750D x 725H
OPTION	2 Sets of Connectors

CODE	DIMENSION
ASAMEETRND9073	900Øx 730H
ASAMEETRND1273	1200Øx 730H
ASAMEETRND1573	1500Øx 730H



### MULTIMEDIA ACOUSTIC WALL

**FEATURES**

Off The Wall Table secured to Melamine and Sonik Acoustic Multimedia Wall / TV Not Included / Verse Base Black



CODE	DIMENSION TABLE
MMACCSOK WLL	750D x 2100L x 950H

### CAFE BENCH

**FEATURES**

Slab End Cafe Bench / 25mm Construction



CODE	DIMENSION
CAFEBENCH2795	2700L x 600Dx 950H
CAFEBENCHBIN	Bin
OPTION	Bin Box Cover
OPTION	Artificial Plants

### FALCON HIGH BENCH

**FEATURES**

High Bench with Curved Contrast Top / Storage Cupboard Below / Built In Planter



CODE	DIMENSION
FALCONHIGHBENCH	2700L x 900D x 950H
OPTION	Artificial Plants

\*Plants Subject to Stock Availability

### OFF THE WALL TABLE

**FEATURES**

Slab End Straight with Bulb End other side with Verse Disc Base More sizes available



CODE	DIMENSIONS
OFFTHEWALL1807	2100W x 800D x 725H
OFFTHEWALL1809	2100W x 800D x 950H
OFFTHEWALLPLNT1807	1800W x 800D x 725H (800W x 200D x 925H)
OFFTHEWALLPLNT1809	1800W x 800D x 950H (800W x 200D x 1150H)

\*Plants Subject to Stock Availability

### FOCUS HIGH BENCH

**FEATURES**

25mm Construction / 46 Standard Colours



CODE	DIMENSION
FOHB150610	1500W x 600D x 950H
FOHB180710	1800W x 750D x 950H
FOHB210710	2100W x 750D x 950H

### CUSTOM WELDED HIGH BENCH

**FEATURES**

Tube Legs Come in Options of 32x 32 or 50 x 50mm Square Tube Legs and 25mm Tops Height 1025mm Suits Barstool Chairs (Seat Height 770H) Height 950mm Suits Counter Stool Chair (Seat Height 650H)



CODE	DIMENSION	TUBE THICKNESS
CSTMWLDHB2107	2100L x 750D x 1000H	32
CSTMWLDHB2409	2400L x 900D x 1000H	32
CSTMWLDHB2107	2100L x 750D x 1000H	50
CSTMWLDHB2409	2400L x 900D x 1000H	50

\*Optional Lockable Castor Wheels

**TORO MEETING TABLE**

Base Finish: Black or White  
Top: Standard 46 Colours



CODE	DIMENSION
TOMTTB12	Ø1200 x 750H

**TORO MEETING TABLE**

Base Finish: Black or White  
Top: Standard 46 Colours



CODE	DIMENSION
TOMTTB09	Ø900 x 750H

**KATO MEETING TABLE**

Base Finish: Chrome  
Top: Standard 46 Colours



CODE	DIMENSION
KTMTTB09	Ø900 x 750H
KTMTTB12	Ø1200 x 750H

**DELTA NOUVEAU MEETING TABLE - 4 LEGS**

Base Finish: Polished Stainless Steel / Black  
Top: Standard 46 Colours



CODE	DIMENSION
IMDESQMT	900W x 900D x 750H
IMDEMTBA12	Ø1200 x 750H

**DELTA NOUVEAU MEETING TABLE - 3 LEGS**

Base Finish: Polished Stainless Steel / Black  
Top: Standard 46 Colours



CODE	DIMENSION
IMDEMTBA7	Ø750 x 750H
IMDEMTBA9	Ø900 x 750H

**LETO MEETING TABLE**

Base Finish: White  
Top: Standard 46 Colours



CODE	DIMENSION
IMLEMT9	Ø900 x 725 - 825H
IMLEMT12	Ø1200 x 725 - 825H

**APOLLO MEETING TABLE**

Base Finish: Chrome  
Top: Standard 46 Colours



CODE	DIMENSION
IMAPMTB9	Ø900 x 750H
IMAPMTB12	Ø1200 x 750H
IMAPMTB15	Ø1500 x 750H
IMAPMTB18	Ø1800 x 750H

**APOLLO MEETING TABLE - BLACK**

Base Finish: Black Matt Finish  
Top: Standard 46 Colours



CODE	DIMENSION
IMAPMTB9	Ø900 x 750H
IMAPMTB12	Ø1200 x 750H
IMAPMTB15	Ø1500 x 750H
IMAPMTB18	Ø1800 x 750H

**LETO MEETING TABLE**

Base Finish: Black  
Top: Standard 46 Colours



CODE	DIMENSION
	Ø900 x 725 - 825H
	Ø1200 x 725 - 825H

**5 WAY HEAVY DUTY MEETING TABLE**

Base Finish: Black / White / Silver / Graphite Ripple  
Top: Standard 46 Colours



CODE	DIMENSION
TB5WHD15	Ø1500 x 725H
TB5WHD18	Ø1800 x 725H
OPTION	Chrome Base Finish

**SUPREME MEETING TABLE**

Base Finish: White (WT) / Black (BL) / Chrome (CR)  
Top: Standard 46 Colours



CODE	DIMENSION
IMSUMTBA9	Ø900 x 725H
IMSUMTBA12	Ø1200 x 725H

**STAR MEETING TABLE**

Base Finish: Brushed Stainless Steel  
Top: Standard 46 Colours



CODE	DIMENSION
IMSTMTBA9	Ø900 x 725H
IMDEMTBA12	Ø1200 x 725H

### SCOPE MEETING TABLE

Base Finish: Black  
Top: Standard 46 Colours



CODE	DIMENSION
IMSCMTBA7	750W x 750D x 725H
IMSCMTBA9	900W x 900D x 725H

### VERSE MEETING TABLE - BLACK

Base Finish: Black  
Top: Standard 46 Colours



CODE	DIMENSION
IMSCBABA7	750Ø x 725H
IMSCBABA9	900Ø x 725H

### VERSE MEETING TABLE - POLISHED

Base Finish: Brushed Stainless Steel  
Top: Standard 46 Colours



CODE	DIMENSION
IMSCMTBA	750Ø x 725H
IMSCMTBA9	900Ø x 725H

### SCOPE DOUBLE MEETING BLACK

Base Finish: Black  
Top: Standard 46 Colours



CODE	DIMENSION
IMSCHB1875	1800W x 750D x 745H
IMSCHB2175	2100W x 750D x 745H

### VERSE DOUBLE MEETING BLACK

Base Finish: Black  
Top: Standard 46 Colours



CODE	DIMENSION
IMVSBABABL1875	1800W x 750D x 745H
IMVSBABABL2175	2100W x 750D x 745H

### VERSE DOUBLE MEETING POLISHED

Base Finish: Polished Stainless Steel  
Top: Standard 46 Colours



CODE	DIMENSION
IMVSMTBABR1875	1800W x 750D x 745H
IMVSMTBABR2175	2100W x 750D x 745H

### SCOPE BAR TABLE

Base Finish: Black  
Top: Standard 46 Colours



CODE	DIMENSION
IMSCBABA7	750W x 750D x 1025H

### VERSE BAR TABLE - BLACK

Base Finish: Black  
Top: Standard 46 Colours



CODE	DIMENSION
IMVSBABAL7	750Ø x 1025H

### VERSE BAR TABLE POLISHED

Base Finish: Chrome  
Top: Standard 46 Colours



CODE	DIMENSION
IMVSBABA7	750Ø x 1025H

### SCOPE HIGHBENCH

Base Finish: Black  
Top: Standard 46 Colours



CODE	DIMENSION
IMSCHB1875	1800W x 750D x 1045H
IMSCHB2175	2100W x 750D x 1045H

### VERSE HIGHBENCH - BLACK

Base Finish: Black  
Top: Standard 46 Colours



CODE	DIMENSION
IMVSBABAL18	1800W x 750D x 1045H
IMVSBABAL21	2100W x 750D x 1045H

### VERSE HIGHBENCH - POLISHED

Base Finish: Polished Stainless Steel  
Included / Top: Standard 46 Colours



CODE	DIMENSION
IMVSBABAR18	1800W x 750D x 1045H
IMVSBABAR21	2100W x 750D x 1045H



The new ergonomics in office spaces are not just about ergonomic chairs and height adjustable desks, it's also about sound absorbing walls. The office environment is an ever changing place and we are moving with it. Our SONIK panels can also be cut into decorative patterns as wall features and in our screen and acoustic pod offerings. Wall panels made to order. **Colours Available:** Light Grey - Mid Grey - Charcoal

**SONIK STANDARD WALL PANEL**

**FEATURES**  
9mm Thickness / Ideal for wall applications

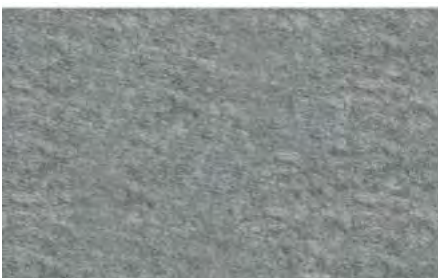

**AXIS SONIK PANEL**

**FEATURES**  
9mm Thickness / Ideal for wall applications

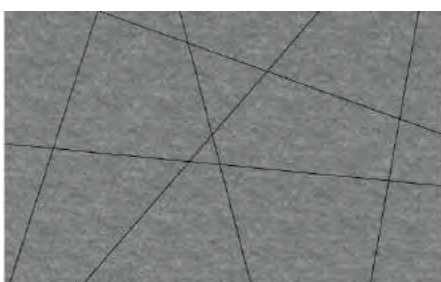

**TILE LINE SONIK PANEL**

**FEATURES**  
9mm Thickness / Ideal for wall applications

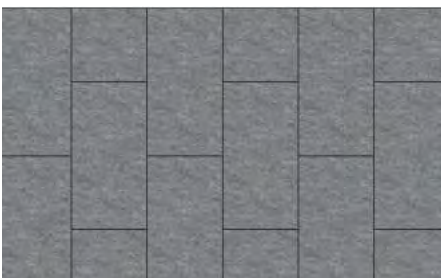

**YIMA SONIK PANEL**

**FEATURES**  
9mm Thickness / Ideal for wall applications

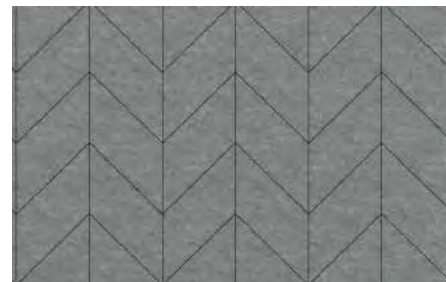

**INK LINE SONIK WALL PANEL**

**FEATURES**  
9mm Thickness / Ideal for wall applications

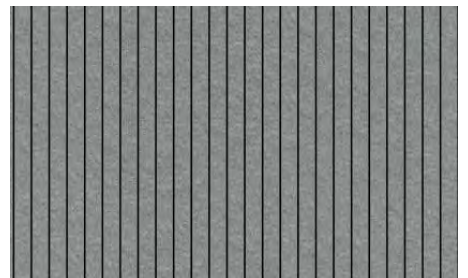

**BUILDERS CUT SONIK PANEL**

**FEATURES**  
9mm Thickness / Ideal for wall applications

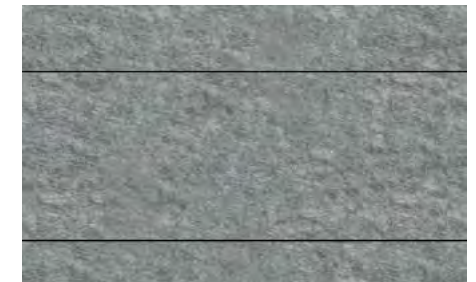



# SONIK DESK SCREENS

## SONIK HUB RECTANGLE & ANGLED FEATURES

Floorstanding Acoustic Desk Booths  
600 Deep Desk Top / 25mm Thick Top

**Colours Available:** Mid Grey



CODE	DIMENSIONS
SNKHUBSTRT	900W x 900D x 1200H

## SONIK HUB - CURVED FEATURES

Fitted With Brackets Beneath Desk for a flawless finish and added strength and integrity  
600 Curved Deep Desk Top / 25mm Thick Top

**Colours Available:** Mid Grey



CODE	DIMENSIONS
SNKHUBCRV	900W x 1200H

## SONIK BISCUIT DIVIDER FEATURES

Biscuit Slide on Sonik Dividers  
600H Overall / 480 Above Desk / More sizes available

**Colours Available:** Mid Grey



ANGLEDBISCUIT

CURVEDBISCUIT

CODE	DIMENSIONS
ANGLEDBISCUIT	750W x 24D x 480H (600H)
CURVEDBISCUIT	750W x 24D x 480H (600H)

## CURVED WRAP SONIK SCREEN FEATURES

Fitted With Brackets Beneath Desk for a flawless finish and added strength and integrity

**Colours Available:** Mid Grey



## ANGLED WRAP SONIK SCREEN FEATURES

Fitted With Brackets Beneath Desk for a flawless finish and added strength and integrity

**Colours Available:** Mid Grey



## ANGLED OPEN END SONIK SCREEN FEATURES

Fitted With Brackets Beneath Desk for a flawless finish and added strength and integrity / Left and Right Options

**Colours Available:** Mid Grey





**50mm SCREENS**

The Ergo-Panel 50 is an all Australian, extremely versatile modular screen system that is made in Melbourne. The screen is fully customizable, giving the client complete control and flexibility over size, style, colour and functionality. Desk mounted or free standing, the screens can be seamlessly integrated into workstation systems utilising a universal power pole/post. Fully integrated cable management systems are available in any number of positions on the screens with the ability for both soft wired or hard wired options.

**Screen Surface Options:** Fabric, Pin Board and Sonik Acoustic Panels



**PALM SONIK DIVIDERS**

**FEATURES**

Melamine Front and Sonik Acoustic Back  
Grooved Detailing On Front Panel Only

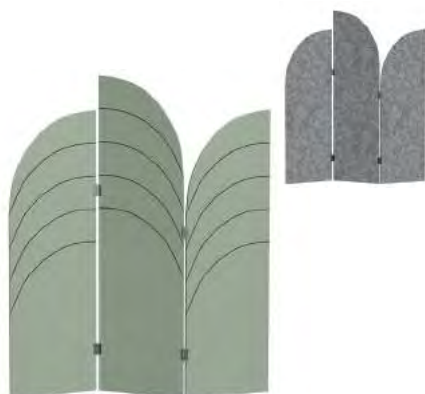

CODE	DIMENSION
PALMSNKDVR	600W x 1600H x (1700H)

**SERENE SONIK STAND**

**FEATURES**

Floorstanding Melamine Stand / Sonik Acoustic Back and Front / Freestanding Decorative Acoustic Space Divider



CODE	DIMENSION
SERENESNKSTND	800W x 1700H

**CONE OF SILENCE**

**FEATURES**

Sonik Acoustic Wall Hanging Booth  
Sizes may vary on application



CODE	DIMENSION
CONEOFSILSNK	800W x 800H

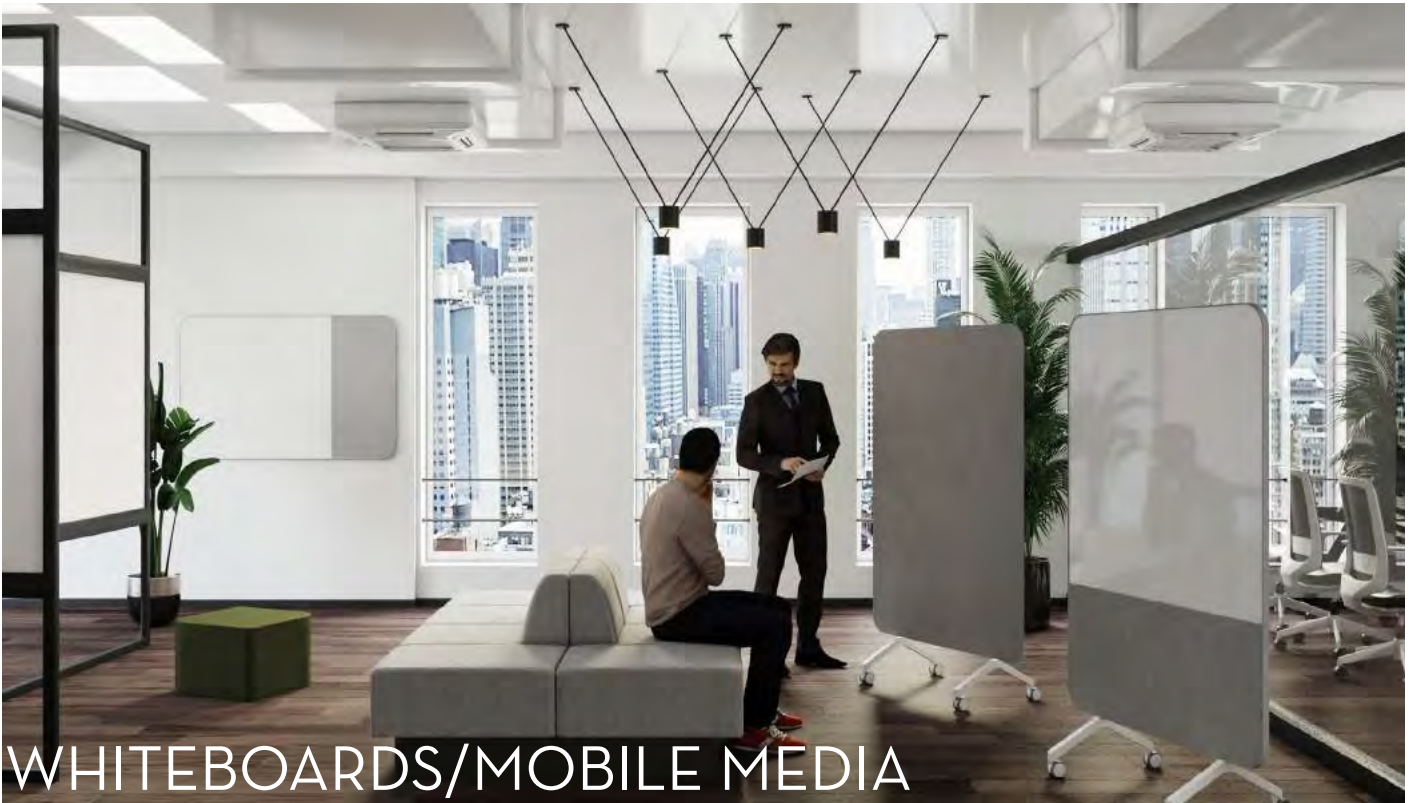

# WHITEBOARDS/MOIBLE MEDIA

## CURVED MOBILE WHITEBOARD

### FEATURES

Designer Range Whiteboard / Double Sided / One Side All Pinnable Fabric / Other Side Part Fabric Part Magnetic Glass White Board 40mm Thickness / Mobile Lockable Castors



CODE	DIMENSION
IASMWBTC12	1200W x 1640H x 40T

## CURVED WALL MOUNT WHITEBOARD

### FEATURES

Magnetic Glass White Board 25mm Thickness / Suitable for Most Walls / Multipurpose Whiteboard and Pinnable Panel/ Aluminium Fasteners Combination Set for Wall Hanging

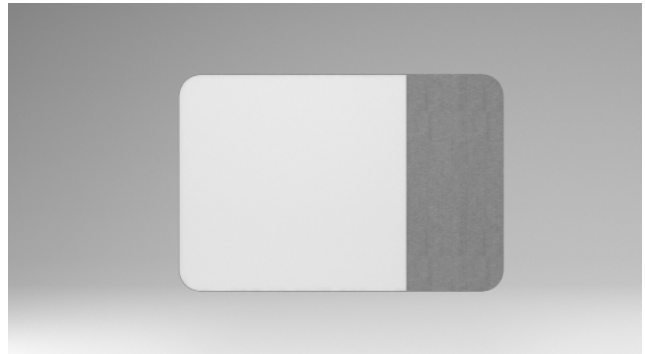

CODE	DIMENSION
IASWMWBTC15	1500W x 1000H x 25T

## MULTIPURPOSE STORAGE WHITE SHEEN DOOR

### FEATURES

1800H includes castors / White Sheen Door / Acoustic open corner / Internal Storage



CODE	DIMENSION
MLTPSTWHITEBRD1318	1300W x 450D x 1800H
OPTION	SONIK Acoustic Panel On Back
OPTION	White Sheen (Whiteboard on Back)

## TV MOBILE UNIT

### FEATURES

TV Not Included/ Spine Door to conceal all cords / internal side shelves / Sturdy Construction / Front Slimline Shelf



CODE	DIMENSION
ICBOS	1200W x 830D x 1600H



# ELECTRIC SIT / STAND

## SELECTRIC RANGE

The Selectric utilises European design and technology and is constructed with a sturdy steel frame, being powered by motor drives. Maximum height is achieved via telescopic legs. The Selectric operation allows the user to easily adjust the worktop height to their individual preference. The master controller also allows the user to set the minimum and maximum heights as well making it perfect for the home or corporate office alike.

## SOLO - 101 NEW GENERATION

Colour : **46 Standard Colours**

Squared Corner

- Remote Desktop Control
- Height Range (Including 25mm Top) 700 -1150H
- 70kg Weight Rating Equally Divided
- Single Motor with Control Unit & Cables
- Black and White Frame Options

CODE	DIMENSION
IMSESO101F51575	1500L x 750D
IMSESO101F51875	1800L x 750D
SONIKSCREEN	1500 ~ 1800L x 24D x 600H



## 201

The first and still our flagship model for sit/ stand desks in Australia. It was the first Sit stand desk in Australia to have the AFRDI blue tick certificate since 2011. It has become the preferred option for the government and corporate users. It features twin motor drives for heavy duty weight, offers reliability and flexibility, the 750mm deep feet give superior stability for 201.

- Includes Master Controller
- Base Finish: White / Black
- Height Range included 25mm Top // 675 - 1325H
- 120kg Weight Max
- Two Motors
- 10 Year Warranty

Squared Corner



CODE	DIMENSION
IMSSESO20115	1500L x 750D
IMSSESO20118	1800L x 750D
IMSSESO2011809	1800L x 900D
IMSSESO2012109	2100L x 900D





### CORNER - 301

The Corner workstation version of the popular Solo 201. It comes as standard with 3 Motor drive/ actuators for each workstation with two Cantilever legs and one post in the corner. It is connected by adjustable beams on both sides and it has a weight rating of 150kg evenly loaded.

Colour Top: 46 Standard Colours

CODE	DIMENSION
IMSSECO30118	1800 x 1800W x 750D
IMSSECO30121	2100 x 2100W x 750D

Base Finish: White / Black (WT) (BL)  
 Height Range included 25mm Top // 675 - 1325H



### CORNER - 120 / 301

The 120/ 301 workstation frame has a width range of 1550-2100mm on both sides and a depth range of 600-900mm making it an extremely flexible option for your 120 degree workstation choice. It is one of the strongest and most heavy duty frames of its type with a 150kg weight rating and will set the standard for others to follow in true sit/stand 120 degree workstations.

Colour Top: 46 Standard Colours

CODE	DIMENSION
IMSE12030112	1200 x 1200W x 750D
IMSE12030115	1350 x 1350W x 750D

Base Finish: White / Black (WT) (BL)  
 Height Range included 25mm Top // 675 - 1325H



### DUO - 402

This is the new egalitarian solution for office ergonomics at a system level. Everyone has the same opportunity to enjoy and be comfortable in their own space. Pods of multiples of (2) can be created by linking frames and screens to make design and procurement simple and predictable with the level of style the modern office requires.

Colour Top: 46 Standard Colours

CODE	DIMENSION
IMSEDU40218	1800 x 1800W x 750D
IMSEDU40221	2100 x 2100W x 750D

Base Finish: White (WT) (BL)  
 Height Range included 25mm Top // 630 - 1290H



### H - FRAME FIXED HEIGHT

Locally made welded H Frame Fixed Height Base / Powdercoat Colours Black and White (or Non Standard available)



### SONIK BACK TO BACK SCREEN

#### FEATURES

Fitted With Brackets Beneath Desk for a flawless finish and added strength and integrity

Colours Available: Mid Grey

CODE	DIMENSIONS
SONIK4021580	1500L x 24D x 900H
SONIK4021880	1800L x 24D x 800H



### SOFT WIRE KIT FOR SELECTRIC

Data Kit: BLACK or WHITE

CODE	STYLE
PWRDTKIT4	Soft Wire Kit





## OPTIC OR SONIK SCREENS

Vista angle version of our linear frame with rectangle 40 x 70mm legs and rails. Solid perimeter frame to create 2 Pods double sided workstation.

Tops: 46 Standard Colour Range

Workstation with scalloped tops included

### SONIK ACOUSTIC SCREENS

- System Type: Solid Panel
- Screen Brackets Included
- House Fabric Colour: Light Grey
- 600H can be set at 400H above desk



Biscuit Dividers p. 53



CODE	DIMENSION
SONIKSCRN15	1500W x 24D x 600H
SONIKSCRN18	1800W x 24D x 600H



24mm Screen Thickness

### OPTIC SCREENS 600H

- System Type: MDF Panel Fabric Fabric Covered
- Screen Brackets Included
- House Fabric Colour: Charcoal (House Fabric)
- Specified Fabrics P.O.A
- 600H can be set between 400-550H above desk



CODE	DIMENSION
ISOUTS1306	1300W x 22D x 600H
ISOUTS1506	1500W x 22D x 600H



House Fabric



22mm Screen Thickness

Tops: 46 Standard Colour Range

Bench Single Sided x 2 pod

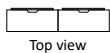

Base Finish: White / Black (Image shown 600H OPTIC Screen)

2 SONIK 600H Screens

CODE	TOP SIZE	OVERALL SIZE	POD
VIS2BEN3009	1500L	3000L x 900D x 725H	2
VIS2BEN3609	1800L	3600L x 900D x 725H	2

2 OPTIC 600H Screens

CODE	TOP SIZE	OVERALL SIZE	POD
VIS2BEN3009	1500L	3000L x 900D x 725H	2
VIS2BEN3609	1800L	3600L x 900D x 725H	2

Bench Single Sided x 3 pod

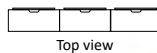

Base Finish: White / Black (Image shown 600H OPTIC Screen)

3 SONIK 600H Screens

CODE	TOP SIZE	OVERALL SIZE	POD
VIS3BEN4509	1500L	4500L x 900D x 725H	3
VIS3BEN5409	1800L	5400L x 900D x 725H	3

3 OPTIC 600H Screens

CODE	TOP SIZE	OVERALL SIZE	POD
VIS3BEN4509	1500L	4500L x 900D x 725H	3
VIS3BEN5409	1800L	5400L x 900D x 725H	3

Bench Double Sided x 2 pod



Base Finish: White / Black (Image shown 600H OPTIC Screen)

1 SONIK 600H Screen

CODE	TOP SIZE	OVERALL SIZE	POD
VIS2SYS1515	1500L	1500L x 1500D x 725H	2
VIS2SYS1815	1800L	1800L x 1500D x 725H	2

1 OPTIC 600H Screen

CODE	TOP SIZE	OVERALL SIZE	POD
VIS2SYS1515	1500L	1500L x 1500D x 725H	2
VIS2SYS1815	1800L	1800L x 1500D x 725H	2

Bench Double Sided x 4 pod

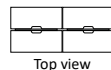

Base Finish: White / Black (Image shown 600H OPTIC Screen)

2 SONIK 600H Screens

CODE	TOP SIZE	OVERALL SIZE	POD
VIS4SYS3015	1500L	3000L x 1500D x 725H	4
VIS4SYS3615	1800L	3600L x 1500D x 725H	4

2 OPTIC 600H Screens

CODE	TOP SIZE	OVERALL SIZE	POD
VIS4SYS3015	1500L	3000L x 1500D x 725H	4
VIS4SYS3615	1800L	3600L x 1500D x 725H	4

Bench Double Sided x 6 pod

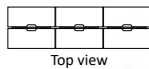

Base Finish: White / Black (Image shown 600H OPTIC Screen)

3 SONIK 600H Screens

CODE	TOP SIZE	OVERALL SIZE	POD
VIS6SYS4515	1500L	4500L x 1500D x 725H	6
VIS6SYS5415	1800L	5400L x 1500D x 725H	6

3 OPTIC 600H Screens

CODE	TOP SIZE	OVERALL SIZE	POD
VIS6SYS4515	1500L	4500L x 1500D x 725H	6
VIS6SYS5415	1800L	5400L x 1500D x 725H	6

120 Degree x 3 pod



Base Finish: White / Black (Image shown 600H OPTIC Screen)

3 SONIK 600H Screens

CODE	OVERALL SIZE	POD
VIS120SYS1306	1350 x 1350L x 600D x 725H	3
VIS120SYS1307	1350 x 1350L x 750D x 725H	3

3 OPTIC 600H Screens

CODE	OVERALL SIZE	POD
VIS120SYS1306	1350 x 1350L x 600D x 725H	3
VIS120SYS1307	1350 x 1350L x 750D x 725H	3



# FORUM WORKSTATIONS

## OPTIC OR SONIK SCREENS

The forum comprises of a sturdy triangular profile leg featuring a 6mm sleek shadow line making it a sleek and modern solution. Available in many configurations to suit your office environment.

Workstation with scalloped tops included

Tops: 46 Standard Colour Range

### SONIK SCREENS

- System Type: Solid Panel
- Screen Brackets Included
- House Fabric Colour: Light Grey
- 600H can be set at 400H above desk



Biscuit Dividers p. 53



24mm Screen Thickness

CODE	DIMENSION
SONIKSCRN1518	1500 ~1800W x 24D x 600H

### OPTIC SCREENS

- System Type: MDF Panel Fabric Fabric Covered
- Screen Brackets Included
- House Fabric Colour: Charcoal (House Fabric)
- Specified Fabrics P.O.A
- 600H can be set between 400~550H above desk



House Fabric



22mm Screen Thickness

CODE	DIMENSION
ISOOTS1306	1300W x 22D x 600H
ISOOTS1506	1500W x 22D x 600H

Bench Single Sided x 1 pod



Top view



Base Finish: White / Black (Image shown 600H OPTIC Screen)

1 SONIK 600H Screen

CODE	TOP SIZE	OVERALL SIZE	POD
FORDES1507	1500L	1500L x 750D x 725H	1
FORDES1807	1800L	1800L x 750D x 725H	1

1 OPTIC 600H Screen

CODE	TOP SIZE	OVERALL SIZE	POD
FORDES1507	1500L	1500L x 750D x 725H	1
FORDES1807	1800L	1800L x 750D x 725H	1

Bench Single Sided x 2 pod

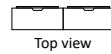

Top view



Base Finish: White / Black (Image shown 600H OPTIC Screen)

2 SONIK 600H Screens

CODE	TOP SIZE	OVERALL SIZE	POD
FORDES3007	1500L	3000L x 750D x 725H	2
FORDES3607	1800L	3600L x 750D x 725H	2

2 OPTIC 600H Screens

CODE	TOP SIZE	OVERALL SIZE	POD
FORDES3007	1500L	3000L x 750D x 725H	2
FORDES3607	1800L	3600L x 750D x 725H	2

Bench Double Sided x 2 pod



Top view



Base Finish: White / Black 1 (Image shown 600H OPTIC Screen)

SONIK 600H Screen

CODE	TOP SIZE	OVERALL SIZE	POD
FOR2SYS15	1500L	1500L x 1500D x 725H	2
FOR2SYS18	1800L	1800L x 1500D x 725H	2

1 OPTIC 600H Screen

CODE	TOP SIZE	OVERALL SIZE	POD
FOR2SYS15	1500L	1500L x 1500D x 725H	2
FOR2SYS18	1800L	1800L x 1500D x 725H	2

Bench Double Sided x 4 pod

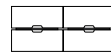

Top view



Base Finish: White / Black (Image shown 600H OPTIC Screen)

2 SONIK 600H Screens

CODE	TOP SIZE	OVERALL SIZE	POD
FOR4SYS3015	1500L	3000L x 1500D x 725H	4
FOR4SYS3615	1800L	3600L x 1500D x 725H	4

2 OPTIC 600H Screens

CODE	TOP SIZE	OVERALL SIZE	POD
FOR4SYS3015	1500L	3000L x 1500D x 725H	4
FOR4SYS3615	1800L	3600L x 1500D x 725H	4

Bench Double Sided x 6 pod

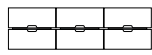

Top view



Base Finish: White / Black (Image shown 600H OPTIC Screen)

3 SONIK 600H Screens

CODE	TOP SIZE	OVERALL SIZE	POD
FOR6SYS4515	1500L	4500L x 1500D x 725H	6
FOR6SYS4515	1800L	5400L x 1500D x 725H	6

3 OPTIC 600H Screens

CODE	TOP SIZE	OVERALL SIZE	POD
FOR6SYS4515	1500L	4500L x 1500D x 725H	6
FOR6SYS4515	1800L	5400L x 1500D x 725H	6

4 Way Workstation (Desk & Return shown)



Top view

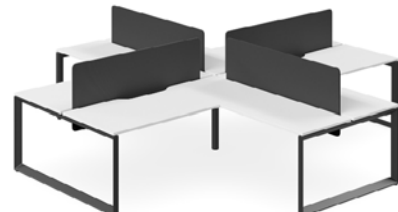

Base Finish: White / Black (Image shown 600H OPTIC Screen)  
Radial or Splayed Tops

4 SONIK 600H Screens

CODE	TOP SIZE	OVERALL SIZE	POD
PLZ4XSYS 18071807	1800L	1800L x 750D x 1800L x 750D x 725H	4

4 OPTIC 600H Screens

CODE	TOP SIZE	OVERALL SIZE	POD
PLZ4XSYS 18071807	1800L	1800L x 750D x 1800L x 750D x 725H	4



# FORUM WORKSTATIONS

## TEK 30 WORKSTATIONS

The forum comprises of a sturdy triangular profile leg featuring a 6mm sleek shadow line making it a sleek and modern solution. Available in many configurations to suit your office environment.

Workstation with scalloped tops included

Tops: 46 Standard Colour Range

### TEK 30 Screen System

30mm Tek is a non-ducted system, if cabling is required external cabling can be supplied by means of cable baskets fitted under desks with soft-wire leads & outlets.

#### 500H Screen

Solid Panel in House Fabric  
 Colour: Charcoal  
 Screen Frame: White or Black / Screen Brackets Included  
 Specified Fabrics P.O.A  
 (Tek 30 Screens Sits 475mm H above desk)

CODE	DIMENSION
ISE30P1505	1500W x 30D x 500H
ISE30P1805	1800W x 30D x 500H



House Fabric



30mm Screen Thickness



#### 700H Screen

Solid Panel in House Fabric  
 Colour: Charcoal  
 Screen Frame: White or Black / Screen Brackets Included  
 Specified Fabrics P.O.A  
 (Tek 30 Screens Sits 475mm H above desk)

CODE	DIMENSION
ISE30P1507	1500W x 30D x 700H
ISE30P1807	1800W x 30D x 700H



House Fabric



30mm Screen Thickness



Bench Single Sided x 1 pod



Top view



Base Finish: White / Black (Image shown 700H TEK Screen)

1 TEK 700H Screen

CODE	TOP SIZE	OVERALL SIZE	POD
FORDES1507	1500L	1500L x 750D x 725H	1
FORDES1807	1800L	1800L x 750D x 725H	1

Bench Single Sided x 2 pod

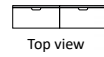

Top view

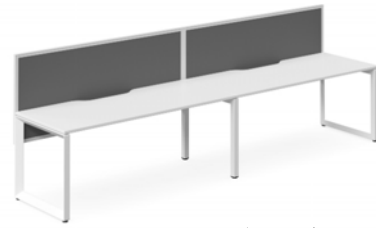

Base Finish: White / Black (Image shown 700H TEK Screens)

2 TEK 700H Screens

CODE	TOP SIZE	OVERALL SIZE	POD
FORDES3007	1500L	3000L x 750D x 725H	2
FORDES3607	1800L	3600L x 750D x 725H	2

Bench Double Sided x 2 pod



Top view

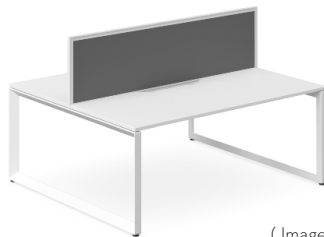

Base Finish: White / Black (Image shown 500H TEK Screen)

1 TEK 500H Screen

CODE	TOP SIZE	OVERALL SIZE	POD
FOR2SYS15	1500L	1500L x 1500D x 725H	2
FOR2SYS18	1800L	1800L x 1500D x 725H	2

Bench Double Sided x 4 pod

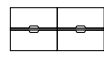

Top view



Base Finish: White / Black (Image shown 500H TEK Screens)

2 TEK 500H Screens

CODE	TOP SIZE	OVERALL SIZE	POD
FOR4SYS3015	1500L	3000L x 1500D x 725H	4
FOR4SYS3615	1800L	3600L x 1500D x 725H	4

Bench Double Sided x 6 pod

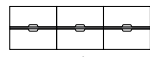

Top view



(Image shown 500H TEK Screens)

Base Finish: White / Black

3 TEK 500H Screens

CODE	TOP SIZE	OVERALL SIZE	POD
FOR6SYS4515	1500L	4500L x 1500D x 725H	6
FOR6SYS4518	1800L	5400L x 1500D x 725H	6

4 Way Workstation (Desk & Return shown)



Top view

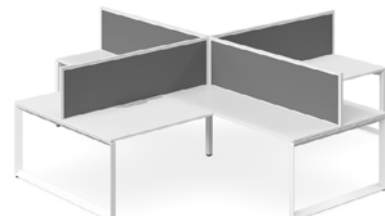

(Image shown 500H TEK Screens)

Base Finish: White / Black

Radial or Splayed Tops

4 TEK 500H Screens

CODE	TOP SIZE	OVERALL SIZE	POD
FOR4XSYS 18071807	1800L	1800L x 750D x 1800L x 750D x 725H	4

SOFT WIRE KIT - WHITE AND BLACK

Data Kit:



1 x Quad GPO



1 x Triple DATA



1 x GPO Bracket

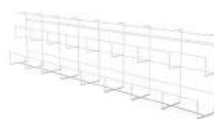

1 x Cable Basket



1 x 2.5m Interconnecting Lead



1 x Starter Socket

CODE	STYLE
PWRDTKIT4	Soft Wire Kit (Suits 1500 ~ 1600 Desk)
	Soft Wire Kit (Suits 1800 ~ 2100 Desk)
	Wall Starter up to 6 Connects

- Soft Wire Kit available in White and Black
- 1 Kit Per Desk when allowing Power and Data



# PLAZA WORKSTATIONS

Tops: 46 Standard Colour Range

## OPTIC OR SONIK SCREENS

The plaza features a 50 x 50mm steel tube leg system. Its lineal look and timeless style can be configured to suit your office work environment.

Workstation with scalloped tops included

### SONIK SCREENS

- System Type: Solid Panel
- Screen Brackets Included
- House Fabric Colour: Light Grey
- 600H can be set at 400H above desk



Biscuit Dividers p. 53

CODE	DIMENSION
SONIKSCRN1518	1500 ~ 1800W x 24D x 600H



24mm Screen Thickness



### OPTIC SCREENS

- System Type: MDF Panel Fabric Fabric Covered
- Screen Brackets Included
- House Fabric Colour: Charcoal (House Fabric)
- Specified Fabrics P.O.A
- 600H can be set between 400~550H above desk

CODE	DIMENSION
ISOOTS1306	1300W x 22D x 600H
ISOOTS1506	1500W x 22D x 600H



House Fabric



22mm Screen Thickness





Bench Single Sided x 1 pod



Base Finish: White / Black (Image shown 600H SONIK Screen)

1 SONIK 600H Screen

CODE	TOP SIZE	OVERALL SIZE	POD
PLZDES1507	1500L	1500L x 750D x 725H	1
PLZDES1807	1800L	1800L x 750D x 725H	1

1 OPTIC 600H Screen

CODE	TOP SIZE	OVERALL SIZE	POD
PLZDES1507	1500L	1500L x 750D x 725H	1
PLZDES1807	1800L	1800L x 750D x 725H	1

Bench Single Sided x 2 pod

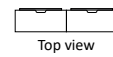

Base Finish: White / Black (Image shown 600H SONIK Screen)

2 SONIK 600H Screens

CODE	TOP SIZE	OVERALL SIZE	POD
PLZDES3007	1500L	3000L x 750D x 725H	2
PLZDES3607	1800L	3600L x 750D x 725H	2

2 OPTIC 600H Screens

CODE	TOP SIZE	OVERALL SIZE	POD
PLZDES3007	1500L	3000L x 750D x 725H	2
PLZDES3607	1800L	3600L x 750D x 725H	2

Bench Double Sided x 2 pod



Base Finish: White / Black (Image shown 600H SONIK Screen)

1 SONIK 600H Screens

CODE	TOP SIZE	OVERALL SIZE	POD
PLZ2SYS15	1500L	1500L x 1500D x 725H	2
PLZ2SYS18	1800L	1800L x 1500D x 725H	2

1 OPTIC 600H Screen

CODE	TOP SIZE	OVERALL SIZE	POD
PLZ2SYS15	1500L	1500L x 1500D x 725H	2
PLZ2SYS18	1800L	1800L x 1500D x 725H	2

Bench Double Sided x 4 pod

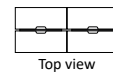

Base Finish: White / Black (Image shown 600H SONIK Screen)

2 SONIK 600H Screens

CODE	TOP SIZE	OVERALL SIZE	POD
PLZ4SYS3015	1500L	3000L x 1500D x 725H	4
PLZ4SYS3615	1800L	3600L x 1500D x 725H	4

2 OPTIC 600H Screens

CODE	TOP SIZE	OVERALL SIZE	POD
PLZ4SYS3015	1500L	3000L x 1500D x 725H	4
PLZ4SYS3615	1800L	3600L x 1500D x 725H	4

Bench Double Sided x 6 pod

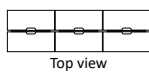

Base Finish: White / Black (Image shown 600H SONIK Screen)

3 SONIK 600H Screens

CODE	TOP SIZE	OVERALL SIZE	POD
PLZ6SYS4515	1500L	4500L x 1500D x 725H	6
PLZ6SYS5415	1800L	5400L x 1500D x 725H	6

3 OPTIC 600H Screens

CODE	TOP SIZE	OVERALL SIZE	POD
PLZ6SYS4515	1500L	4500L x 1500D x 725H	6
PLZ6SYS5415	1800L	5400L x 1500D x 725H	6

4 Way Workstation (Desk & Return shown)

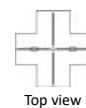

Base Finish: White / Black  
Radial or Splayed Tops (Image shown 600H SONIK Screen)

4 SONIK 600H Screens

CODE	TOP SIZE	OVERALL SIZE	POD
PLZ4XSYS 18071807	1800L	1800L x 750D x 1800L x 750D x 725H	4

3 OPTIC 600H Screens

CODE	TOP SIZE	OVERALL SIZE	POD
PLZ4XSYS 18071807	1800L	1800L x 750D x 1800L x 750D x 725H	4



## TEK 30 SCREENS

The Plaza features a 50 x 50mm steel tube leg system. Its lineal look and timeless style can be configured to suit your office work environment.

Workstation with scalloped tops included

Tops: 46 Standard Colour Range

### TEK 30 Screen System

30mm Tek is a non-ducted system, if cabling is required external cabling can be supplied by means of cable baskets fitted under desks with soft-wire leads & outlets.

#### 500H Screen

Solid Panel in House Fabric  
 Colour: Charcoal  
 Screen Frame: White or Black / Screen Brackets Included  
 Specified Fabrics P.O.A  
 (Tek 30 Screens Sits 475mm H above desk)

CODE	DIMENSION
ISE30P1505	1500W x 30D x 500H
ISE30P1805	1800W x 30D x 500H



House Fabric



30mm Screen Thickness



#### 700H Screen

Solid Panel in House Fabric  
 Colour: Charcoal  
 Screen Frame: White or Black / Screen Brackets Included  
 Specified Fabrics P.O.A  
 (Tek 30 Screens Sits 475mm H above desk)

CODE	DIMENSION
ISE30P1507	1500W x 30D x 700H
ISE30P1807	1800W x 30D x 700H



House Fabric



30mm Screen Thickness



Bench Single Sided x 1 pod



Top view



Base Finish: White / Black (Image shown 700H TEK Screen)

1 TEK 700H Screen

CODE	TOP SIZE	OVERALL SIZE	POD
PLZDES1507	1500L	1500L x 750D x 725H	1
PLZDES1807	1800L	1800L x 750D x 725H	1

Bench Single Sided x 2 pod

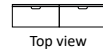

Top view



Base Finish: White / Black (Image shown 700H TEK Screens)

2 TEK 700H Screens

CODE	TOP SIZE	OVERALL SIZE	POD
PLZDES3007	1500L	3000L x 750D x 725H	2
PLZDES3607	1800L	3600L x 750D x 725H	2

Bench Double Sided x 2 pod



Top view



(Image shown 500H TEK Screen)

Base Finish: White / Black

1 TEK 500H Screen

CODE	TOP SIZE	OVERALL SIZE	POD
PLZ2SYS15	1500L	1500L x 1500D x 725H	2
PLZ2SYS18	1800L	1800L x 1500D x 725H	2

Bench Double Sided x 4 pod

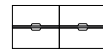

Top view



(Image shown 500H TEK Screens)

Base Finish: White / Black

2 TEK 500H Screen

CODE	TOP SIZE	OVERALL SIZE	POD
PLZ4SYS3015	1500L	3000L x 1500D x 725H	4
PLZ4SYS3615	1800L	3600L x 1500D x 725H	4

Bench Double Sided x 6 pod

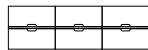

Top view



(Image shown 500H TEK Screens)

Base Finish: White / Black

3 TEK 500H Screens

CODE	TOP SIZE	OVERALL SIZE	POD
PLZ6SYS4515	1500L	4500L x 1500D x 725H	6
PLZ6SYS4515	1800L	5400L x 1500D x 725H	6

4 Way Workstation (Desk & Return shown)



Top view



(Image shown 500H TEK Screens)

Base Finish: White / Black  
Radial or Splayed Top

4 TEK 500H Screens

CODE	TOP SIZE	OVERALL SIZE	POD
PLZ4XSYS 18071807	1800L	1800L x 750D x 1800L x 750D x 725H	4



# METAL STORAGE

The Lunar metal storage options offer quick and easy storage solutions. Use our versatile mobile pedestal or tambour door cupboards to help keep supplies neat and accessible. Matching planter boxes are available to sit on the tambour door unit, bring the workplace to life with plants integrated into your office space. Whatever your choice is, you've come to the right place for storage cabinets.



## LUNAR METAL MOBILE PEDESTALS



White



Silver Pearl



Charcoal



Black

CODE	DIMENSION
IMLUMP3L	390W x 500D x 595H

- Lockable 2 Drawers + File Drawer
- Pencil Tray Included
- Adjustable Divider in Top Drawer
- Fully Assembled

## LUNAR METAL MOBILE CADDY

- Lockable 2 Drawers + File Drawer
- Pencil Tray Included
- Adjustable Divider in Top Drawer
- Fully Assembled
- White Only



Right Hand Door



Left Hand Door

CODE	DIMENSION
IMLUCAMP	900W x 500D x 595H

## 1 DRAWER + FILE MOBILE PEDESTAL

- Lockable 1 Drawer + File Drawer
- Pencil Tray Included
- Adjustable Divider in Top Drawer
- Suitable for sit/stand Desks
- Fully Assembled
- White Only



CODE	DIMENSION
IMLUMP2LWT	390W x 500D x 495H

**LUNAR TAMBOUR DOOR CABINET - 750mmW**



**PRODUCT BREAKDOWN**

**FEATURES**

Metal Construction / 2 Internal Shelves / Lockable Tambour Doors

\*Plants Subject To Availability

CODE	DIMENSION
IMLUTDC3T07WT	750W x 450D x 1095H
IMLUPB07WT	750W x 450D x 240H (Planter Box)
OPTION	*2 Dracaena Plants + Pebbles or Barks



900W - 3 Holes



Black Bark



Artificial Dracaena Plant

**LUNAR TAMBOUR DOOR CABINET - 900mmW**



**PRODUCT BREAKDOWN**

**FEATURES**

Metal Construction / 2 Internal Shelves / Lockable Tambour Doors

\*Plants Subject To Availability

CODE	DIMENSION
IMLUTDC3T09WT	900W x 450D x 1095H
IMLUPB09WT	900W x 450D x 240H (Planter Box)
OPTION	*3 Dracaena Plants + Pebbles or Bark



900W - 3 Holes



Black Bark



Artificial Dracaena Plant

**LUNAR SLIDING DOOR CABINET - 900mm W**



**PRODUCT BREAKDOWN**

**FEATURES**

Metal Construction / 2 Internal Shelves / Lockable Sliding Doors / Matching Colour Handles

\*Plants Subject To Availability

CODE	DIMENSION
IMLUSDC3T09	900W x 450D x 1095H
IMLUPB	900W x 450D x 240H (Planter Box)
OPTION	*3 Dracaena Plants + Pebbles or Bark



900W - 3 Holes



Black Bark



Artificial Dracaena Plant



# BREAKOUT SEATING

The office breakout area is an integral part of any office space. When designing a space these are a few important items to consider, soft seating with acoustic properties, coffee tables, phone charger station, garden walls and a small fridge for refreshments and don't forget bins and last but not least a coffee station hub. We have designed stylish products to cover all of these needs.

## MINI SPACE

### FEATURES

The mini space allows you the freedom of a quiet acoustic booth to steal a moment alone that is a loose piece of furniture



## AUDITORIUM SEATING

### FEATURES

The auditorium seating is made to order as per your specifications / Optional heavy duty castors



## ALPINE ACOUSTIC SPACES

### FEATURES

Each Acoustic Booth can accommodate one Konnect Seat to take a call or have a impromptu meeting with an option of a foldable table. Each booth is made according to your measurements and requirements. Booths can sit face to face.



## KONNECT BUILT IN

### FEATURES

Konnect Seats can be built in as pictured for a more decorative feel in waiting areas / Also featured is our Belt Line Decorative Wall





**EADU ARM CHAIR**

Code: ICEDARLG - Light Grey  
 Seat Height: 390(H)  
 Overall: 690(W) x 780(D) x 830(H)  
 Seat & Back - Fabric Upholstered  
 Base - Black Powder-coated Steel



**EADU - DARK BLUE**

Code: ICEDARDB - Dark Blue  
 Seat Height: 390(H)  
 Overall: 690(W) x 780(D) x 830(H)  
 Seat & Back - Fabric Upholstered  
 Base - Black Powder-coated Steel



**EADU - BURNT ORANGE**

Code: ICEDAROR - Burnt Orange  
 Seat Height: 390(H)  
 Overall: 690(W) x 780(D) x 830(H)  
 Seat & Back - Fabric Upholstered  
 Base - Black Powder-coated Steel



**EADU - PLUM**

Code: ICEDARPL - Plum  
 Seat Height: 390(H)  
 Overall: 690(W) x 780(D) x 830(H)  
 Seat & Back - Fabric Upholstered  
 Base - Black Powder-coated Steel



**EADU - TAN PU**

Code: ICEDARTA - Tan  
 Seat Height: 390(H)  
 Overall: 690(W) x 780(D) x 830(H)  
 Seat & Back - Fabric Upholstered  
 Base - Black Powder-coated Steel



**EADU - CHARCOAL NEW**

Code: ICEDARDG - Dark Charcoal  
 Seat Height: 390(H)  
 Overall: 690(W) x 780(D) x 830(H)  
 Seat & Back - Fabric Upholstered  
 Base - Black Powder-coated Steel



**EADU - FORREST GREEN**

Code: ICEDARGN - Forrest Green  
 Seat Height: 390(H)  
 Overall: 690(W) x 780(D) x 830(H)  
 Seat & Back - Fabric Upholstered  
 Base - Black Powder-coated Steel



**MIA CHAIR - GREEN**

Code: ICMOCTCH  
 Seat Height: 460(H)  
 Overall: 465W x 450D x 820H  
 Seat & Back - Green Fabric Upholstered  
 Base - Steel Powder Coated Black



**OPI OTTOMAN - LARGE**

**SMALL**

Code: ICEDOTLG - CHARCOAL  
 Overall:  
 630 (W) x 630 (D) x 430 (H)  
 Seat Height: 430(H)  
 Colour: Charcoal

Code: ICEDOTMG - FORREST GREEN  
 Overall:  
 430 (W) x 430 (D) x 430 (H)  
 Seat Height: 430(H)  
 Colour Forrest Green



# SOFT SEATING

Soft seating and breakout chairs are becoming more and more important in any breakout area as visitor chairs and sofas can create comforting warm and welcoming environment to any organization.



SG DG  
Limited Edition

### KONNECT CORNER

Code: ICKOLBDG  
Seat Height: 420(H)  
Overall: 750(W) x 750(D) x 710(H)  
Material: Seat & Back - Grey / Silver Grey Fabric Upholstered  
Base - Steel Chrome Finish



SG DG  
Limited Edition

### KONNECT MIDDLE

Code: ICKOSBDG  
Seat Height: 420(H)  
Overall: 550(W) x 750(D) x 710(H)  
Material: Seat & Back - Grey / Silver Grey Fabric Upholstered  
Base - Steel Chrome Finish



SG DG  
Limited Edition

### KONNECT OTTOMAN

Code: ICKOOTDG  
Seat Height: 420(H)  
Overall: 550(W) x 750(D) x 420(H)  
Material: Seat & Back - Grey / Silver Grey Fabric Upholstered  
Base - Steel Chrome Finish



CONFIGURATION - A  
Konnect Corner: x 2



### KONNECT BOX

CODE	DIMENSION
KONBOX	300W x 750D x 380H



CONFIGURATION - B  
Konnect Ottoman: x 4



CONFIGURATION - C  
Konnect Middle: x 4  
Konnect Ottoman: x 4  
Built in Base in 46 Colours p. 87





### ASPEN SOFA

Code: ICAS3SSOTA  
 Seat Height: 400H  
 Overall: 2400W x 800D x 780H  
 Material: Seat Tan PU  
 Base - Steel Black Finish



### LOLA LOUNGE

Code: ICLO1SBL - Black    Code: ICLO1SGN - Green  
 Seat Height: 390(H)  
 Overall: 760(W) x 650(D) x 760(H)  
 Material: Seat & Back - Black Fabric Upholstered  
 Base - Black Aluminium Finish



### NOOR - LOW BACK

GR

Code: ICNOLBLOMG  
 Seat Height: 410(H)  
 Overall: 1500(W) x 750(D) x 800(H)  
 Material: Seat - Grey Fabric Upholstered  
 Back - Grey Fabric Upholstered  
 Base - Steel Black Finish



### NOOR - HIGH BACK

GR

Code: ICNOHBLOMG  
 Seat Height: 410(H)  
 Overall: 1500(W) x 750(D) x 1250(H)  
 Material: Seat - Grey Fabric Upholstered  
 Back - Grey Fabric Upholstered  
 Base - Steel Black Finish



### KAMINO 1 SEATER

GR

Code: ICKM1SGRGR  
 Seat Height: 440(H)  
 Overall: 880(W) x 610(D) x 760(H)  
 Material: Seat - Grey Fabric Upholstered  
 Back - Dark Grey PU  
 Base - Steel Chrome Finish



### KAMINO 2 SEATER

GR

Code: ICKM2SGRGR  
 Seat Height: 440(H)  
 Overall: 1380(W) x 610(D) x 760(H)  
 Material: Seat - Grey Fabric Upholstered  
 Back - Dark Grey PU  
 Base - Steel Chrome Finish



# TASK AND BOARDROOM CHAIRS



## KEY TASK

Code: ICKYMBMEBL  
 Seat Height: 435 - 535(H)  
 Overall: 620(W) x 580(D) x 920 - 1020(H)  
 Material: Back - Mesh  
 Seat - Fabric Upholstered  
 Base - Nylon 5 Way Base  
 Fully Assembled 5 Year Warranty



## LENNOX TASK

Code: ICELEMBMEBL  
 Seat Height: 460 - 560(H)  
 Overall: 630(W) x 610(D) x 970 - 1070(H)  
 Material: Back - Mesh  
 Seat - Fabric Upholstered  
 Base - Black Nylon 5 Way Base  
 Fully Assembled 5 Year Warranty



Back View

## KNOX TASK CHAIR

Code: ICKNBMEWT  
 Seat Height: 465 ~ 565(H)  
 Overall: 585(W) x 570(D) x 960 ~ 1060(H)  
 Material: Seat - Mesh and Fabric Seat Removable Arms  
 Base - White Nylon  
 Fully Assembled 5 Year Warranty  
 Weight Rating: 120kg



## LINC TASK ALLUMINIUM BASE

Code: ICLIMBTABL (NYLON)/ ICLIMBTAPA (ALUMINIUM)  
 Seat Height: 440 - 570(H)  
 Overall: 690(W) x 660(D) x 910 - 1095(H)  
 Material: Back - Mesh / Seat - Fabric Upholstered  
 Base - Nylon/ Polished Aluminium 5 Way  
 Fully Assembled 5 Year Warranty  
 Weight Rating: 120kg



## NYLON BASE





**BERKELEY BLACK FRAME - TAN**

Code: ICBEMBPUTA (TAN)  
 Seat Height: 440 - 540(H)  
 Overall: 580(W) x 630(D) x 880 - 960(H)  
 Material: Seat - Synthetic Leather  
 Base - Black Aluminium 5 Way Base  
 Fully Assembled 5 Year Warranty  
 Weight Rating: 120kg



**BERKELEY BLACK FRAME - BLACK**

Code: ICBEMPUBL (BLACK)  
 Seat Height: 440 - 540(H)  
 Overall: 580(W) x 630(D) x 880 - 960(H)  
 Material: Seat - Synthetic Leather  
 Base - Black Aluminium 5 Way Base  
 Fully Assembled 5 Year Warranty  
 Weight Rating: 120kg



**TURIN CHAIR - CHROME/BLACK**

Code: ICTUGRMBSL  
 Seat Height: 440 - 525(H)  
 Overall: 580W x 630D x 880-960H  
 Material: Seat - Synthetic Leather Removable Arms  
 Base - Polished Aluminium 5 Way Base  
 Fully Assembled 5 Year Warranty  
 Weight Rating: 120kg



**TURIN CHAIR - ALL BLACK**

Code: ICTUGRMBSLBL  
 Seat Height: 440 - 525(H)  
 Overall: 580W x 630D x 880-960H  
 Material: Seat - Synthetic Leather Removable Arms  
 Base - Black Aluminium 5 Way Base  
 Fully Assembled 5 Year Warranty  
 Weight Rating: 120kg



**MILANO MID BACK CHAIR- CHROME/BLACK**

Code: ICMIGRMBSL  
 Seat Height: 465 - 550(H)  
 Overall: 580(W) x 630(D) x 880 - 960(H)  
 Material: Seat - Synthetic Leather Removable Arms  
 Base - Polished Aluminium 5 Way Base  
 Fully Assembled 5 Year Warranty  
 Weight Rating: 120kg



**MILANO MID BACK CHAIR - TAN AND BLACK**

Code: ICMIGRBLMBSLBL (BLACK) ICMIGRBLMBSLBL (TAN)  
 Seat Height: 465 - 550(H)  
 Overall: 580(W) x 630(D) x 880 - 960(H)  
 Material: Seat - Synthetic Leather Removable Arms  
 Base - Black Aluminium 5 Way Base  
 Fully Assembled 5 Year Warranty  
 Weight Rating: 120kg



# TRAINING & MEETING CHAIRS



**RYDER CHAIR**

Code: IFRYTRBL (Black) IFRYTRGR (Grey) IFRYTRMA (Green)  
 Seat Height: 470(H)  
 Overall: 480W x 470D x 790H  
 Seat & Back - UV Protected Plastic Stackable  
 Fully Assembled 5 Year Warranty  
 Weight Rating: 120kg



**RAZAR CHAIR**      **FABRIC SEAT**      **PU SEAT**

Code: ICRAWRFA (Fabric Seat) ICRAWRPU (PU Seat)  
 Seat Height: 470(H)  
 Overall: 573W x 605D x 865H  
 Seat: Fabric or PU Back: Mesh - Nylon Armrest  
 Base: Metal Tube Legs Powdercoat Black  
 Fully Assembled 5 Year Warranty  
 Weight Rating: 120kg



**MYNA CHAIR**

Code: IFFLMEBL  
 Seat Height: 450(H)  
 Overall: 545W x 550D x 765H  
 Solid Steel Tube Stackable Legs  
 Weight Rating: 110kg



**FLIK CHAIR**

Code: IFFLMEBL  
 Seat Height: 450(H)  
 Overall: 545W x 550D x 765H  
 Solid Steel Tube Fixed Armrests / Solid Steel Tube Stackable Legs  
 Seat and Back: PU  
 Fully Assembled 5 Year Warranty  
 Weight Rating: 120kg



**EMBOSS CHAIR**

Code Black: ICEMVSWT(WHITE SEAT + CHROME SLED) ICEMVSBL (BLACK SEAT + BLACK SLED) ICEMVSWWT (WHITE SEAT + WHITE SLED)  
 Seat Height: 450(H)  
 Overall: 550(W) x 500(D) x 830(H)  
 Seat & Back - UV Protected Plastic  
 Base - Steel Chrome Finish  
 \*Interchangeable Base & Seat / Stackable up to 4 Chairs  
 Fully Assembled 5 Year Warranty  
 Weight Rating: 120kg



Embossed Pattern



**MOZZIE SLED CHAIR**

DG

Code: ICMOSLCH  
 Seat Height: 450(H)  
 Overall: 450(W) x 465(D) x 820(H)  
 Seat & Back - Dark Grey Fabric Upholstered  
 Base - Steel Powder Coated Black Sled  
 Stackable up to 3 Chairs  
 Fully Assembled 5 Year Warranty  
 Weight Rating: 120kg



No Arms

**MAKO**

GR

Code: ICMATRSCBL  
 Seat Height: 450(H)  
 Overall: 460(W) x 510(D) x 845(H)  
 Seat - Grey Fabric Upholstered  
 Back - UV Protected Plastic  
 Base - Steel Powder Coated Black  
 Fully Assembled 5 Year Warranty  
 Weight Rating: 120kg



**EMBOSS CASTOR CHAIR**

Code: ICEMCTBL  
 Seat Height: 450(H)  
 Overall: 465W x 450D x 820H  
 Seat & Back - UV Protected Plastic  
 Black 4-Way Base With PU Castors  
 \*Interchangeable Base & Seat  
 Fully Assembled 5 Year Warranty  
 Weight Rating: 120kg



Embossed Pattern



**MOZZIE CASTOR CHAIR**

DG

Code:ICMOCTCH  
 Seat Height: 460(H)  
 Overall: 465W x 450D x 820H  
 Seat & Back - Dark Grey Fabric Upholstered  
 Base - Steel Powder Coated Black / PU Castors  
 Fully Assembled 5 Year Warranty  
 Weight Rating: 120kg



**YOYO TUB CHAIR**

CH

Code: ICYOCTMTCH  
 Seat Height: 460 - 560(H)  
 Overall: 630(W) x 555(D) x 810-910(H)  
 Seat & Back - Dark Grey Fabric Upholstered  
 Base - Black Aluminium 5 Way Base  
 Fully Assembled 5 Year Warranty  
 Weight Rating: 120kg



# NIKOLA SEATING

Nikola is a trending meeting chair style, perfect for adding a luxe feeling to any space. Ideal for conference, training, meeting and waiting areas. Made with a cast alloy frame and armrests, in Black or White powdercoat matte finish. Choice of 5 fabric colours and a Tan PU.

Colour Codes:

GREY= GR

BLUE= BU

GREEN= GN

PLUM= PL

CHARCOAL= CH

TAN PU= TA



## CASTORS + ARMS

Seat Height: 430 ~ 530 (H)

Seat: 480 (W) x 450 (D) x 420 (H)

Overall: 640 (W) x 620 (D) x 880~970 (H)

White Base



ICNICTAWT - GR



ICNICTAWT - BU



ICNICTAWT - GN



ICNICTAWT - PL



ICNICTAWT - CH



ICNICTAWT - TA

Black Base



ICNICTABL - GR



ICNICTABL - BU



ICNICTABL - GN



ICNICTABL - PL



ICNICTABL - CH



ICNICTABL - TA

**CASTOR BASE**

Seat Height: 430 ~ 530 (H)  
 Seat: 480 (W) x 450 (D) x 450 (H)  
 Overall: 640 (W) x 620 (D) x 880~970 (H)

White Base



ICNICTBL - GR



ICNICTWT - GR



ICNICTWT - BU



ICNICTWT - GN



ICNICTWT - PL



ICNICTWT - CH



ICNICTWT - TA

Black Base



ICNICTBL - BU



ICNICTBL - GN



ICNICTBL - PL



ICNICTBL - CH



ICNICTBL - TA

**SLED + ARMS**

Seat Height: 465 (H)  
 Seat: 480 (W) x 450 (D) x 420 (H)  
 Overall: 600 (W) x 540 (D) x 860 (H)

White Base



ICNISLABL - GR



ICNISLAWT - GR



ICNISLAWT - BU



ICNISLAWT - GN



ICNISLAWT - PL



ICNISLAWT - CH



ICNISLAWT - TA

Black Base



ICNISLABL - BU



ICNISLABL - GN



ICNISLABL - PL



ICNISLABL - CH



ICNISLABL - TA

**SLED BASE**

Seat Height: 440 (H)  
 Seat: 480 (W) x 450 (D) x 420 (H)  
 Overall: 580 (W) x 540 (D) x 860 (H)

White Base



ICNISLBL - GR



ICNISLWT - GR



ICNISLWT - BU



ICNISLWT - GN



ICNISLWT - PL



ICNISLWT - CH



ICNISLWT - TA

Black Base



ICNISLBL - BU



ICNISLBL - GN



ICNISLBL - PL



ICNISLBL - CH



ICNISLBL - TA



# STOOLS



## FLAT TOP STOOL

Codes: FLATSTOOL  
 Seat Height: 650(H)  
 Overall: 440(W) x 345(D) x 650(H)  
 Material: Seat - Tasmanian Oak Wooden Round 30mm Thick  
 Base - Steel Black Heavy Duty Frame



## SADDLE STOOL

Codes: SADDLESTOOL  
 Seat Height: 650(H)  
 Overall: 370(W) x 370(D) x 650(H)  
 Material: Seat - Tasmanian Oak Wooden Saddle Shaped Seat  
 Base - Steel Black Heavy Duty Frame



## MOZZIE COUNTER STOOL

Code: ICMOCOCH  
 Seat Height: 660(H)  
 Overall: 480(W) x 490(D) x 845(H)  
 Seat & Back - Charcoal Fabric Upholstered  
 Base - Steel Powder Coated Black



## MOZZIE BAR STOOL

Code: ICMOBSCH  
 Seat Height: 780(H)  
 Overall: 480(W) x 490(D) x 950(H)  
 Seat & Back - Charcoal Fabric Upholstered  
 Base - Steel Powder Coated Black



## EMBOSS COUNTER STOOL

Codes: ICEMCOWT (WHITE SEAT + WHITE BASE)  
 ICEMCOBL (BLACK SEAT + BLACK BASE)  
 Seat Height: 650(H)  
 Overall: 510(W) x 515(D) x 835(H)  
 Seat & Back - UV Protected Plastic  
 Base - Steel Powder Coated Black or White / Chrome Finish  
 \*Interchangeable Base & Seat



Embossed Pattern



## EMBOSS BAR STOOL

Codes: ICEMBS (WHITE SEAT + CHROME BASE)  
 ICEMBSBL (BLACK SEAT + BASE)  
 ICEMBSWWT (WHITE SEAT + BASE)  
 Seat Height: 770(H) Overall: 510(W) x 515(D) x 945(H)  
 Seat & Back - UV Protected Plastic  
 Base - Steel Powder Coated Black or White / Chrome Finish  
 \*Interchangeable Base & Seat



Embossed Pattern



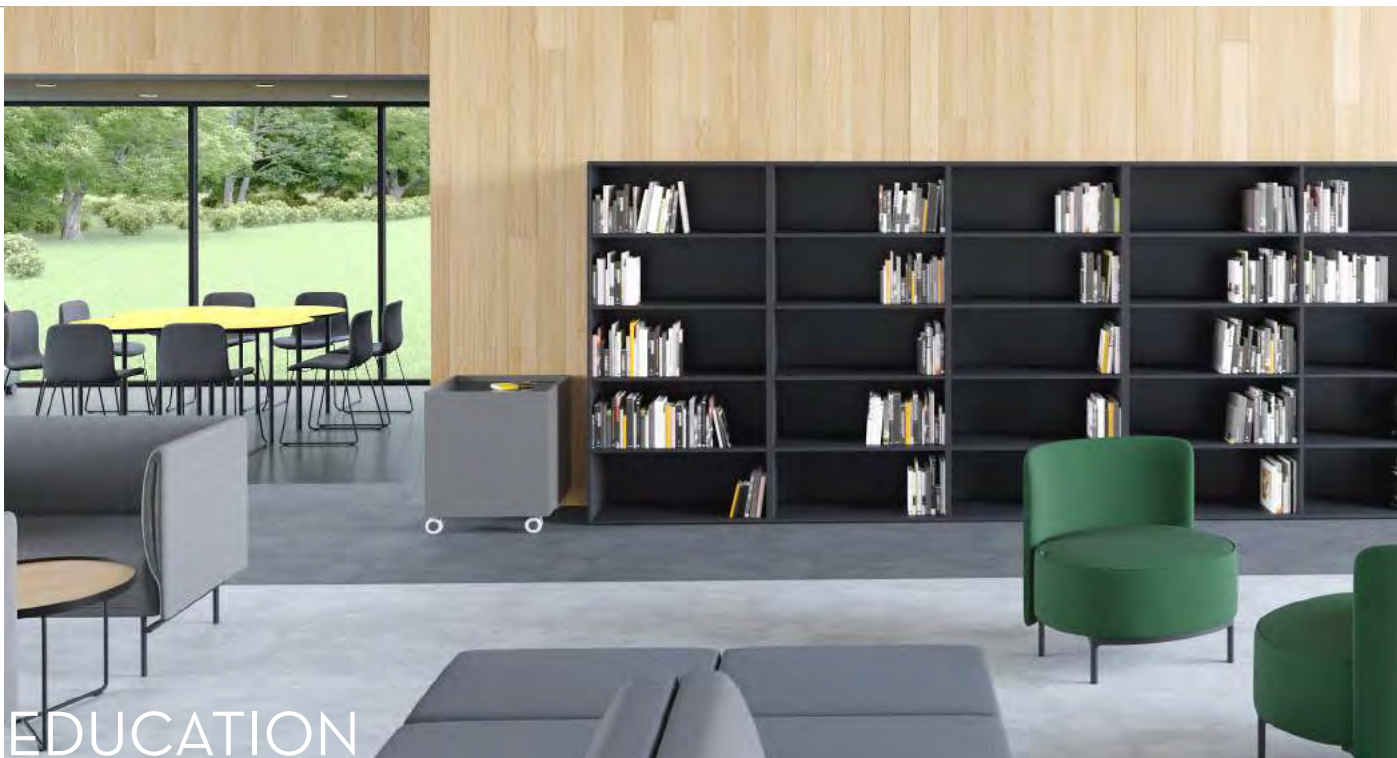

# EDUCATION

### CELL TABLE

18mm MelamineTop  
25x25mm Steel Black tube frame  
Top Finish Options: **46 Standard Colours**



### TRI TABLE

18mm MelamineTop  
25x25mm Steel Black tube frame  
Top Finish Options: **46 Standard Colours**



### WELDED TABLES

25mm MelamineTop  
25mm Steel Black tube frame  
Top Finish Options: **46 Standard Colours**



### VOLT FLIP TABLE

Base Finish: Black + Silver Pearls  
Top Finish Options: **46 Standard Colours**



CODE	DIMENSION
IMVOFLBA7	Ø700 x 725H
IMVOFLBA8	Ø800 x 725H
IMVOFLBA9	Ø900 x 725H

### T-LEG STUDENT DESK



CODE	DIMENSION	TUB
SDHA0606	600W x 600D	1
SDHA1206	1200W x 600D	1

### MOBILE MAGAZINE RACK

Perspex Fascias  
18mm Melamine + Acrylic Perspex  
Heavy duty lockable PU swivel castors



### MOBILE TOTE BOX METAL TROLLEY

- 18mm Melamine Top (Available in Grey Only)
- 25 x 25mm Graphite Ripple Steel tube frame
- Plastic storage boxes
- Heavy duty lockable PU swivel castors



CODE	DIMENSION	TUB
TBTR05	540W x 420D x 873H	5
TBTR10	992W x 420D x 873H	10
TBTR15	1450W x 420D x 873H	15

### MOBILE TOTE BOX MELAMINE TROLLEY

- 18mm Melamine Carcass
- Plastic storage boxes
- Heavy duty lockable PU swivel castors Melamine Finish Options: **p.87**



CODE	DIMENSION	TUB
TBMTR05	415W x 454D x 886H	5
TBMTR10	810W x 454D x 886H	10
TBMTR15	1203W x 454D x 886H	15



# LOCKERS

As communal and shared workplaces are becoming the new norm in the working environments and with more open floor plans presenting themselves lockers have never had a more integral part to play. Besides providing storage they can become breakout walls and separate zones where people can gather. Simply transform into a pinnable acoustic wall by simply applying a Sonik Panel on the back and sides or white board for that matter or upgrade to a welded locker garden refer to page. 25

## LOCKERS

46 Standard Colour Range

### LOCKER SPECS - Important Info

All lockers come as 1 Bay, 2 Bay & 3 Bay combos Only  
Maximum 3 Bays due to weight restrictions

#### Internal Carcass Finish Options:

- 18mm Melamine White or Black Only WT BL

#### Internal Carcass Custom Finish Options (P.O.A)

- Colour swatch page 87

#### Doors Finish Options:

- Colour swatch page 87

#### Kicker: BL

- Available in Black only

#### From wall to wall:

- Finish of End Side Panels: White or Black WT BL

### STANDARD LOCKER DIMENSION

DIMENSION 300W x 500D x 1800H

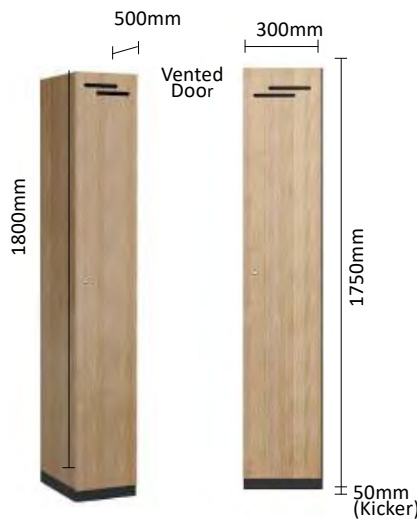

### NEW LOCKER DESIGN FEATURE

Locker doors are now being made with a contrasting edge to match the internal carcass colour to enhance the shadowline of the lockers to give them extra depth and dimension.



### END PANELS - DEFAULT INTERNAL CARCASS EXPOSED

Finish of End Side Panel default to the internal carcass colour White or Black unless specified

### TYPES OF LOCKS



Cupboard Lock



Latch for Padlock



### FINISHED END PANELS MATCHING DOOR COLOUR

To Add Matching End Panels to freestanding exposed locker unit

### 1 DOOR LOCKERS

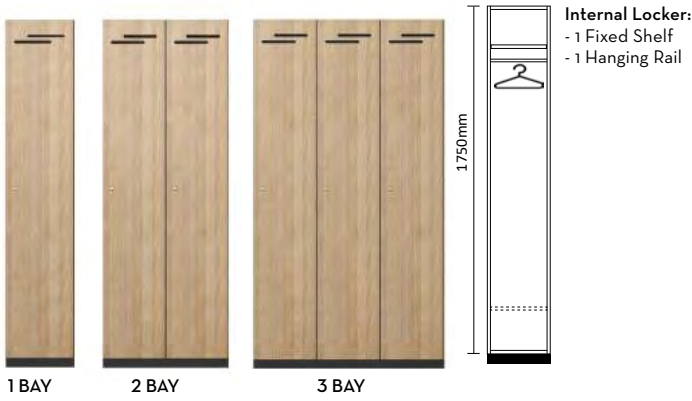

CODE	QUANTITY	NO OF DOORS
LOCK01	1 Bay of 1 Door Locker 300mm (W)	1 DOORS
	2 Bays of 1 Door Locker 600mm (W)	2 DOORS
	3 Bays of 1 Door Locker 900mm (W)	3 DOORS

### 2 DOOR LOCKERS



CODE	QUANTITY	NO OF DOORS
LOCK02	1 Bay of 2 Door Lockers 300mm (W)	2 DOORS
	2 Bays of 2 Door Lockers 600mm (W)	4 DOORS
	3 Bays of 2 Door Lockers 900mm (W)	6 DOORS

### 3 DOOR LOCKERS

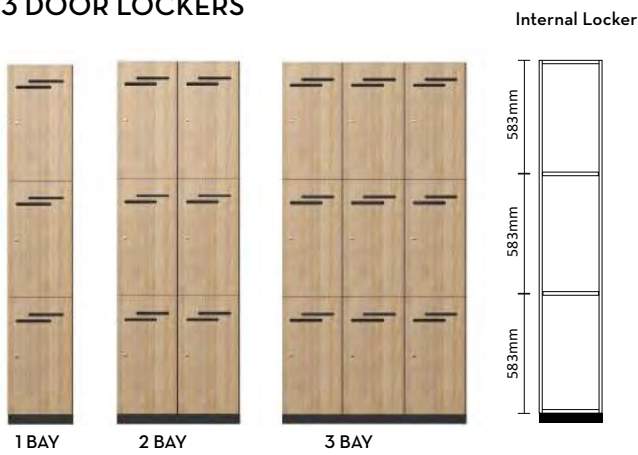

CODE	QUANTITY	NO OF DOORS
LOCK03	1 Unit of 3 Lockers 300mm (W)	3 DOORS
	2 Bays of 3 Door Locker 600mm (W)	6 DOORS
	3 Bays of 3 Door Locker 900mm (W)	9 DOORS

### 4 DOOR LOCKERS

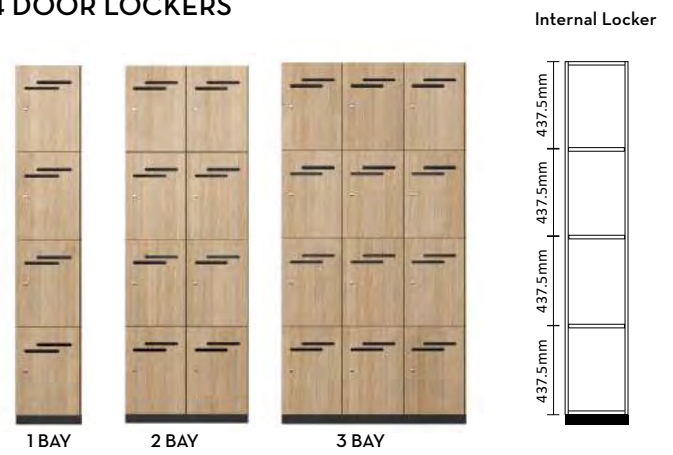

CODE	QUANTITY	NO OF DOORS
LOCK04	1 Bay of 4 Door Locker 300mm (W)	4 DOORS
	2 Bays of 4 Door Locker 600mm (W)	8 DOORS
	3 Bays of 4 Door Locker 900mm (W)	12 DOORS

### 5 DOOR LOCKERS

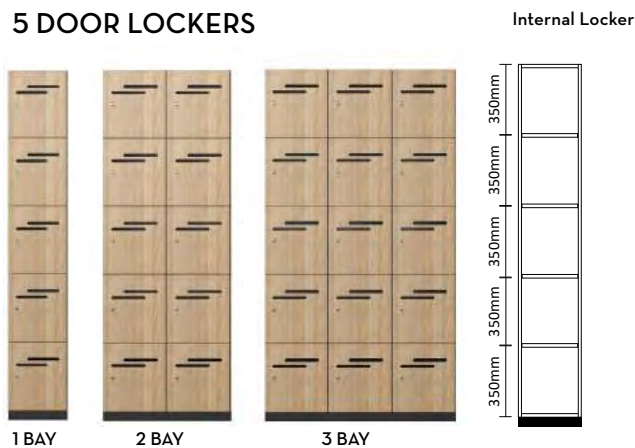

CODE	QUANTITY	NO OF DOORS
LOCK05	1 Bay of 5 Door Locker 300mm (W)	5 DOORS
	2 Bays of 5 Door Locker 600mm (W)	10 DOORS
	3 Bays of 5 Door Locker 900mm (W)	15 DOORS

### PUZZLE DOOR LOCKERS

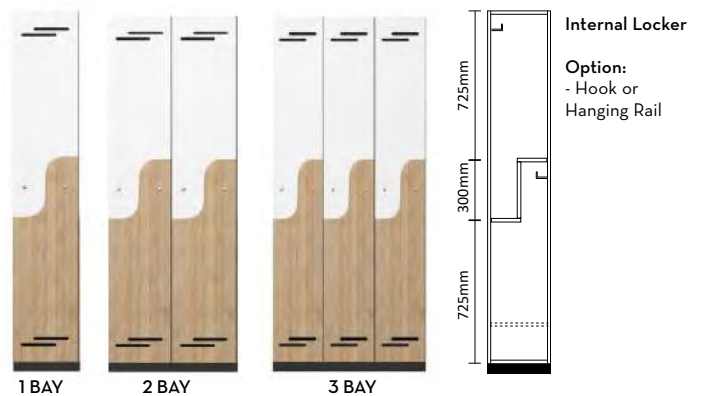

CODE	QUANTITY	NO OF DOORS
PUZLOCK	1 Bay of Puzzle Door Locker 300mm (W)	2 DOORS
	2 Bays of Puzzle Door Locker 600mm (W)	4 DOORS
	3 Bays of Puzzle Door Locker 900mm (W)	6 DOORS



# CC PLUS STORAGE

They CC plus range may be an oldie but its still a goodie. Originally designed way back as a integration of two product ranges, it still serves a purpose in today's office requirements, it can be made in any size and colour combinations from our 46 colours on offer.



**DESK HEIGHT STORAGE WITH TOP OPEN**

**BOOKCASE**

CODE	DIMENSION
CLBC7-8	900W x 450D x 725H
CLBC7-8	900W x 600D x 725H



**LATERAL FILING CABINET**

2 Double Width File Drawers

CODE	DIMENSION
CLLFC	900W x 600D x 725H



**FILING BUFFET**

4 File Drawers Bank

CODE	DIMENSION	DRWS
CLFB0904	910W x 450D x 725H	4
CLFB1304	1355W x 450D x 725H	6
CLFB1804	1800W x 450D x 725H	8
CLFB0906	910W x 600D x 725H	4
CLFB1306	1355W x 600D x 725H	6
CLFB1806	1800W x 600D x 725H	8



**SLIDING DOOR CREDENZA**

Sliding Doors with Handles / Adjustable Feet/ Desk High With Top

CODE	DIMENSION	DOORS
CLB0907	900W x 450D x 725H	2
CLB01207	1200W x 450D x 725H	2



**SLIDING DOOR BUFFET**

Adjustable Feet

CODE	DIMENSION	DOORS
CLB1507	1500W x 450D x 725H	2
CLB1807	1800W x 450D x 725H	2
CLB2107	2100W x 450D x 725H	2
CLB2407	2400W x 450D x 725H	2



**HINGED DOOR BUFFET**

Adjustable Feet

CODE	DIMENSION	DOOR
CLBH0907	900W x 450D x 725H	2
CLBH1507	1500W x 450D x 725H	4
CLBH1807	1800W x 450D x 725H	4
CLBH2109	2100W x 450D x 725H	4
CLBH2407	2400W x 450D x 725H	4

**DEFAULT HANDLE**



**ARCH HANDLE**  
BLACK CHARCOAL SILVER  
IHARCH64

**OPTIONS**

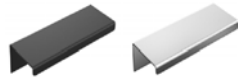

**STEALTH HANDLE**  
BLACK + SILVER  
IHLP100P



**STUTTART HANDLE**  
SILVER  
IHC128BN



**BOW HANDLE**  
BLACK + SILVER  
LARGE: HALB MEDIUM: IHBOW96 SMALL: HASB



**BLADE HANDLE**  
BLACK  
IHBLA128BL



**FILING CABINET 2 File Drawers**

CODE	DIMENSION	DRAWERS
CLFC2	465W x 505D x 725H	2



**FILING CABINET 3 File Drawers**

CODE	DIMENSION	DRAWERS
CLFC3	465W x 505D x 977H	3



**FILING CABINET 4 File Drawers**

CODE	DIMENSION	DRAWERS
CLF4	465W x 505D x 1270H	4



**TALL CUPBOARD 2 DOORS**  
Adjustable Shelves / Adjustable Feet

CODE	DIMENSIONS
CLCP2	900h x 900w x 450d
CLCP2	1200h x 900w x 450d
CLCP2	1500h x 900w x 450d
CLCP2	1800h x 900w x 450d
CLCP2	2100h x 900w x 450d



**BOOKCASE STORAGE CUPBOARD**  
3 Adjustable Shelves / Adjustable Feet/ 1 Fixed Shelf

CODE	DIMENSIONS
CLCPBC	1800h x 900w x 450d



**4 DOOR STORAGE CUPBOARD**  
3 Adjustable Shelves / Adjustable Feet/ 1 Fixed Shelf

CODE	DIMENSIONS
CLCP4	1800h x 900w x 450d



**BOOKCASES**  
Adjustable Shelves

CODE	DIMENSION	SHELVES
CLBC0909	900W x 300D x 900H	2
CLBC1209	1200W x 300D x 900H	2
CLBC1509	1500W x 300D x 900H	4
CLBC1809	1800W x 300D x 900H	4
CLBC2109	2100W x 300D x 900H	4



**BOOKCASES**  
Adjustable Shelves

CODE	DIMENSION	SHELVES
CLBC	900W x 300D x 1200H	3
CLBC	1200W x 300D x 1200H	3
CLBC	1500W x 300D x 1200H	6
CLBC	1800W x 300D x 1200H	6
CLBC	2100W x 300D x 1200H	6



**BOOKCASES**  
Adjustable Shelves

CODE	DIMENSION	SHELVES
BXBC900	900W x 300D x 1800H	4
BXBC1200	1200W x 300D x 1800H	4
BXBC1500	1500W x 300D x 1800H	8
BXBC1800	1800W x 300D x 1800H	8

**LOCK OPTIONS**

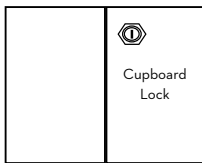
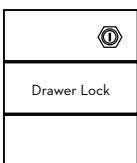

CODE	STYLE	DOORS
DRALOCK	Drawer Multi Lock	
CUPLOCK	Cupboard Lock	2
CREDENZA	Locks for 4 Doors	4
	Locks for 6 Doors	6



**PIGEON HOLE BOOKCASE**  
Adjustable Shelves / Adjustable Feet

CODE	DIMENSIONS
CLPHBC	1800H x 900W x 330D



**MOBILE PEDESTAL 2 Drawer + File**

CODE	DIMENSION
CLMP3	410W x 505D x 650H

### MA SOLO MONITOR ARM



\*Monitor arms require scalloped tops to fit with screens

### BIONIK DUAL MONITOR ARM



Dual - Black

CODE	DIMENSION
IHMASOMMBL(Solo)	400W x 100D x 400H

CODE	DIMENSION
IHBNDUMMBL (Dual)	220 - 400W x 100D x 400H

### SOFT WIRE KIT - BLACK AND WHITE



### ACCESSORIES FOR WORKSTATION & SELECTRIC RANGE

#### CORD SNAKE (For Selectric Only)



S4 - White S2 - Black

- Power & Data Segregated Underdesk Cord Snake  
- 1300mm Cord Snake

#### C1 FIXED CPU HOLDER



White Black

- Inner Distance 128-248mm Width Adjustable  
- Inner Distance 392-552mm Height Adjustable

CODE	STYLE
PWRDKIT4	Soft Wire Kit (Suits 1500 ~ 1600 Desk)
	Soft Wire Kit (Suits 1800 ~ 2100 Desk)
	Wall Starter up to 6 Connects

CODE	DIMENSION
IMS4LKUBC (S4)	42W x 30D x 1300H
IMSECAUM (S2)	45W x 23D x 1300H

CODE	DIMENSION
IMC1CPU	220-275W x 23D x 440-600H

### HAND SANITIZER STAND

Hinged door in back for access



### LECTERN

Front Panel Feature Ink Line / LED Option



### PERSPEX SCREENS - SNEEZE GUARDS



CODE	DIMENSION
PRSPCSRNG080	600W x 800H
PRSPCSRN1280	1200W x 800H

### BINS

Internal large bin included  
Door for access to Bin



CODE	DIMENSION
BINOPENTOP	500D x 500W x 1100H
BINPLANTER	500D x 500W x 1100H
OPTION	Plants to Suit

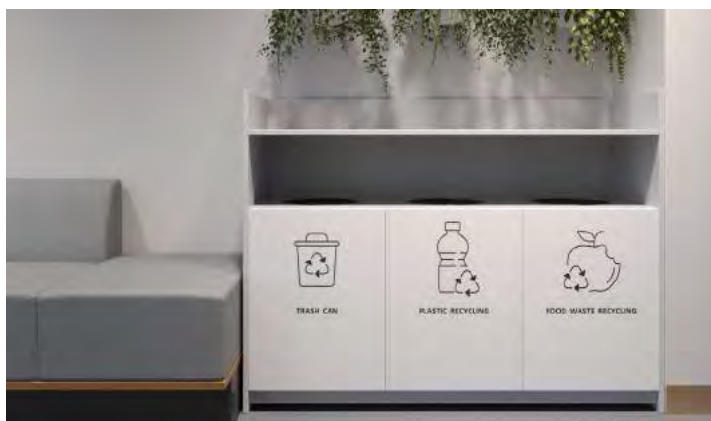

\*Image shows BINOPENTOP x 3

\*Decals Not Included

# Woodgrains

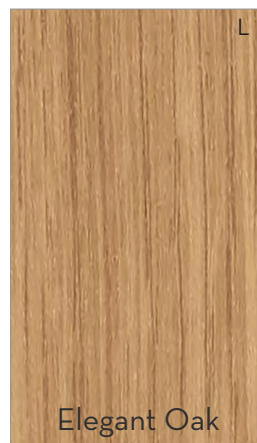
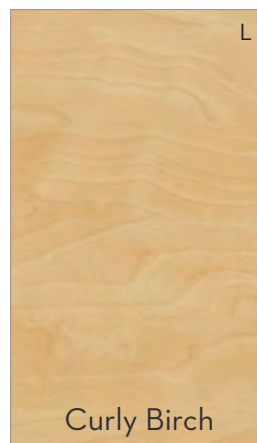

# Solids, Cool Toned Woodgrains and Textures

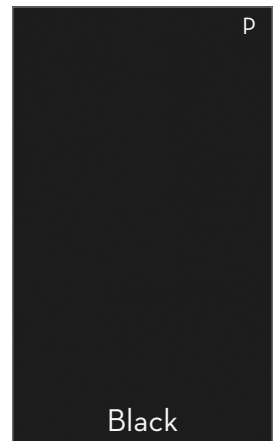
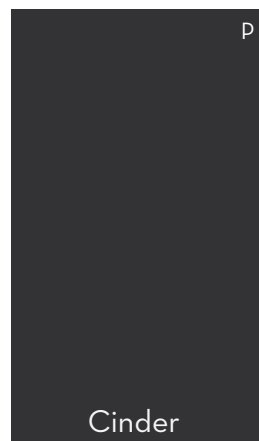
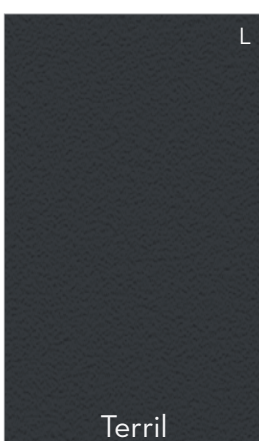
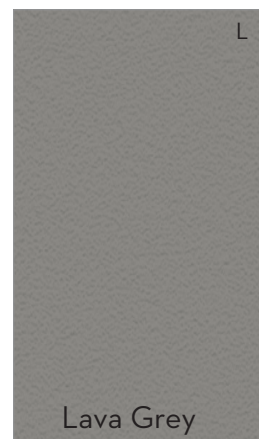
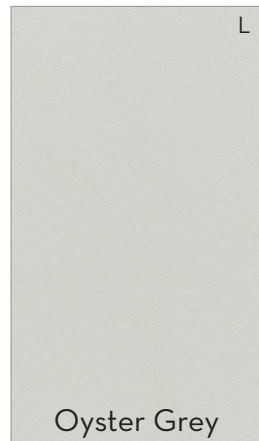
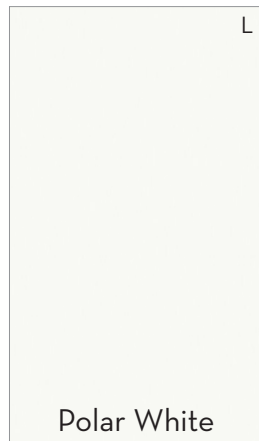
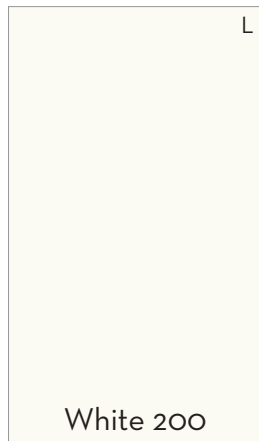
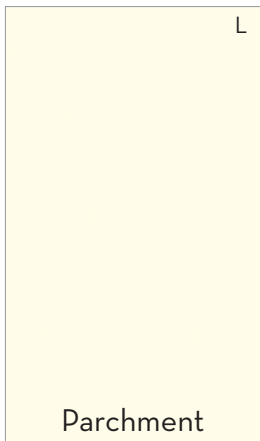



# Feature Colours

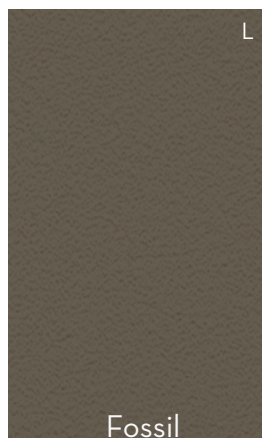
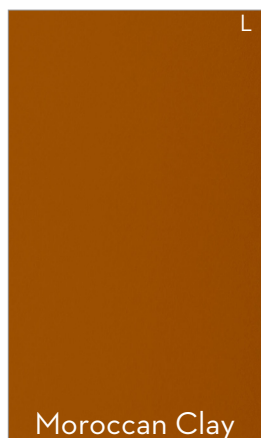

---

# Non - Standard Colour Range

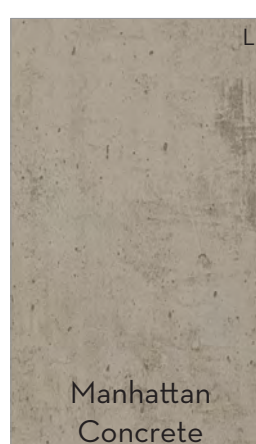
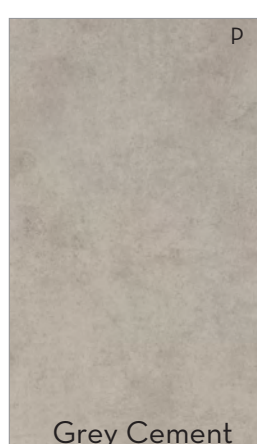
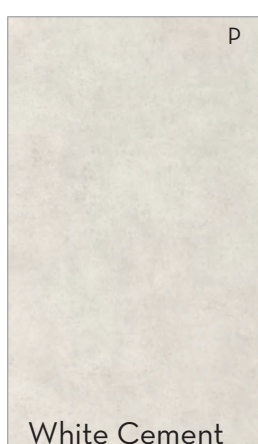
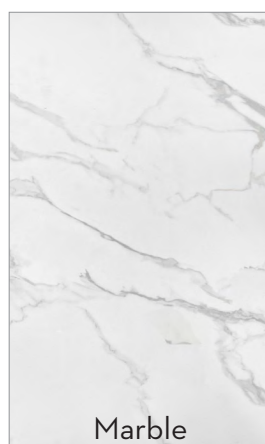



Our commercial range comes in a variety of colours, thicknesses and sheet sizes specifically designed for commercial application. Our range of colours are available in MELAMINE making it easy for you to choose the design features you are looking for.

The commercial range will inspire unlimited design possibilities for any commercial environment and give your design concept a fresh and unique look.

Our commercial range is committed to an eco-friendly and sustainable environment. It is an intrinsic part of the way we do business daily.

Our decisions are made so that they have minimum negative impact on the environment. Our product is manufactured from managed and renewable plantation pine and is Australian Forestry Standard chain of custody certified. All products are manufactured from E0 or E1.

- L** Laminex
- P** polytec
- F** FORMICA®



\* Subject to change, some colours may not apply \*

Version 4

- 18mm / 25mm Standard Particleboard
- MDF Board available on request -
- Custom Colour & Colour Combinations can be specified - (Please refer to our sales representative for more information)



[www.iccorporateinteriors.com.au](http://www.iccorporateinteriors.com.au)

**IC**  
CORPORATE INTERIORS

Phone: (03) 8802 9630

Email: [info@iccorporateinteriors.com.au](mailto:info@iccorporateinteriors.com.au)

Website: [www.iccorporateinteriors.com.au](http://www.iccorporateinteriors.com.au)